

Concurrent Algorithms (Overview)

Prof R. Guerraoui

Distributed Computing Laboratory

- https://dcl.epfl.ch/site/education/ca_2019 -



In short

***This course is about the principles
of concurrent computing***

Today

- ☛ Logistics

- ☛ Motivation

- ☛ Content

WARNING

- This course is different from the course : **Distributed Algorithms**
- shared **memory** vs **message** passing
- It does make a lot of sense to take both

This course

- Theoretical but no specific theoretical background is required
- Exercices throughout the semester
- Project (30%) + Exam (70%)

ALGORITHMS FOR CONCURRENT SYSTEMS

Rachid Guerraoui
Petr Kuznetsov



New York Times, 8 May 2004: Major chip manufacturers announced what is perceived as a major paradigm shift in computing:

Multiprocessors vs Faster processors

Intel ... [has] decided to focus its development efforts on «dual core» processors ... with two engines instead of one, allowing for greater efficiency because the processor workload is essentially shared.

Multicores **are** everywhere

- ☞ **Dual-core** commonplace in laptops
- ☞ **Quad-core** in desktops
- ☞ **Dual quad-core** in servers
- ☞ **All major chip manufacturers produce multicore CPUs**
 - **Oracle Niagara** (8 cores, 32 threads)
 - **Intel Xeon** (4 cores)
 - **AMD Opteron** (4 cores)

Multicores **are** everywhere

- ☞ **Quad-core** in laptops
- ☞ **Octa-core** in desktops
- ☞ **2*12 cores** in servers
- ☞ **All major chip manufacturers produce multicore CPUs**
 - **Oracle Sparc** (32 cores, 256 threads)
 - **Intel Xeon** (12-16 cores)
 - **AMD Opteron** (12-16 cores)

AMD Opteron (4 cores)

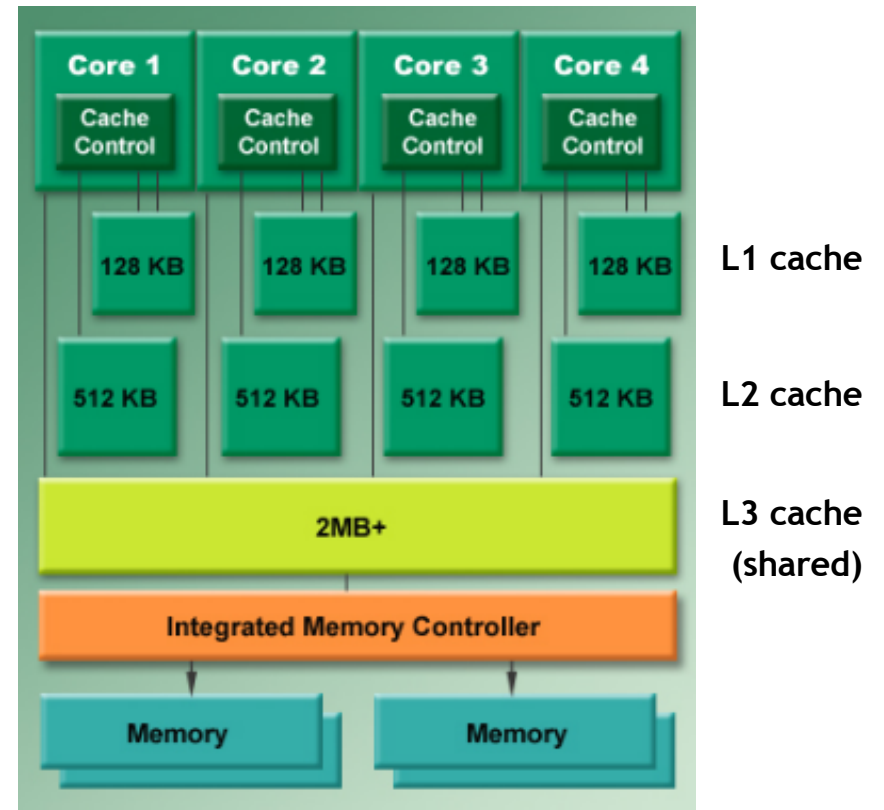
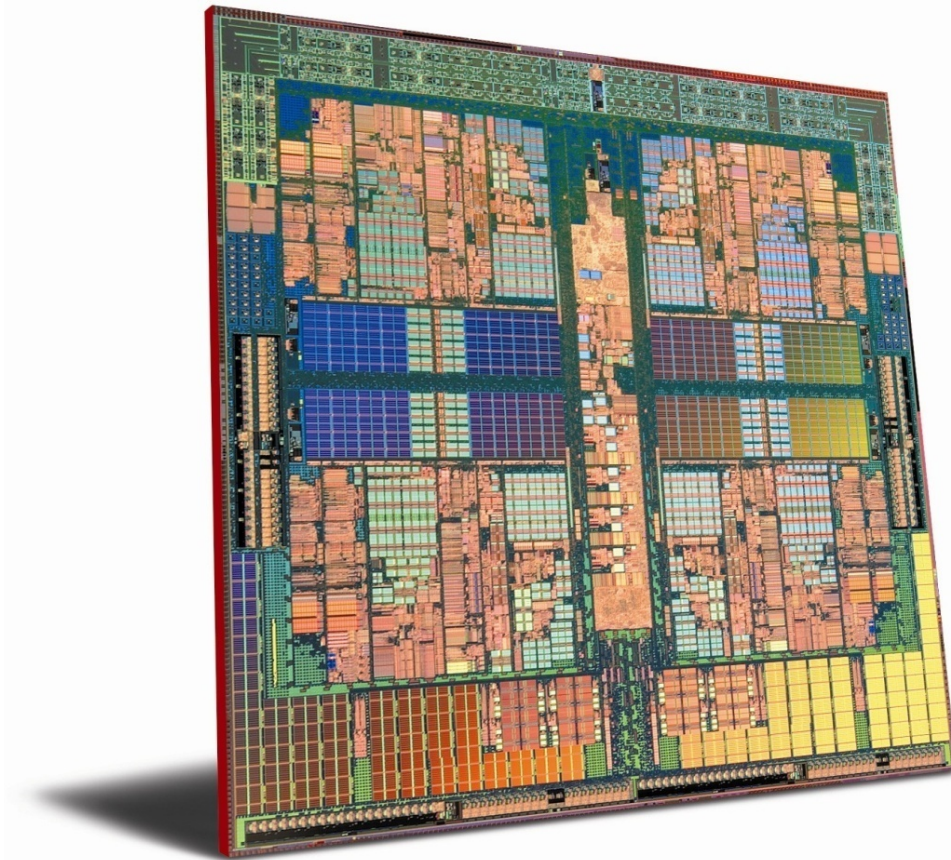

Niagara CPU2 (8 cores)

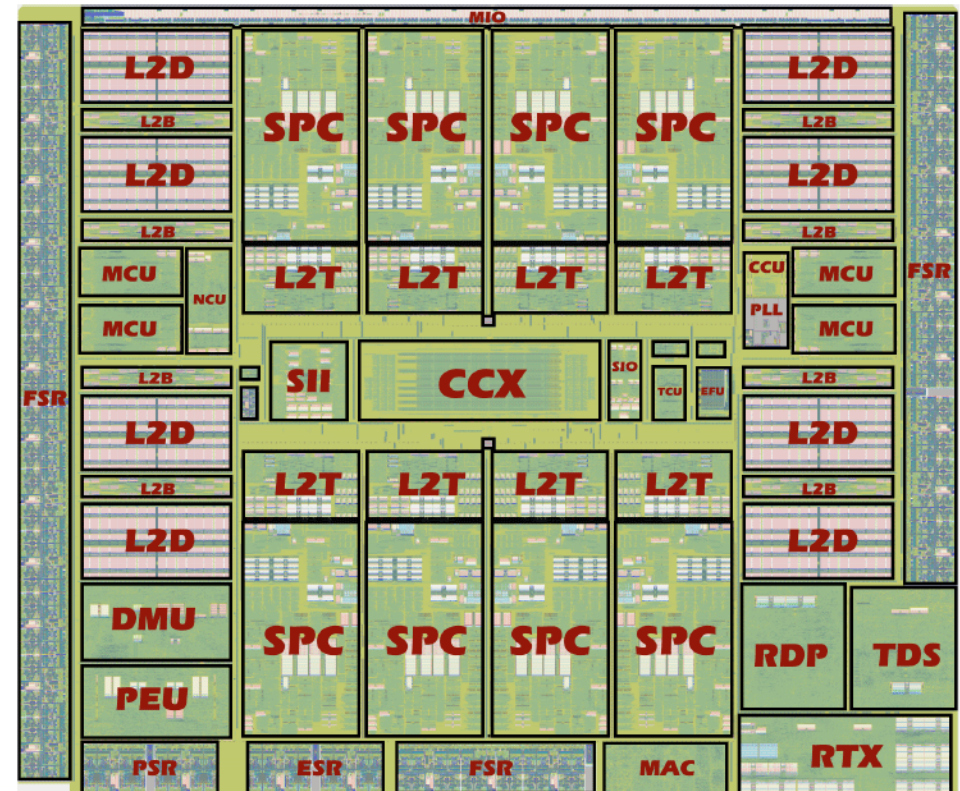
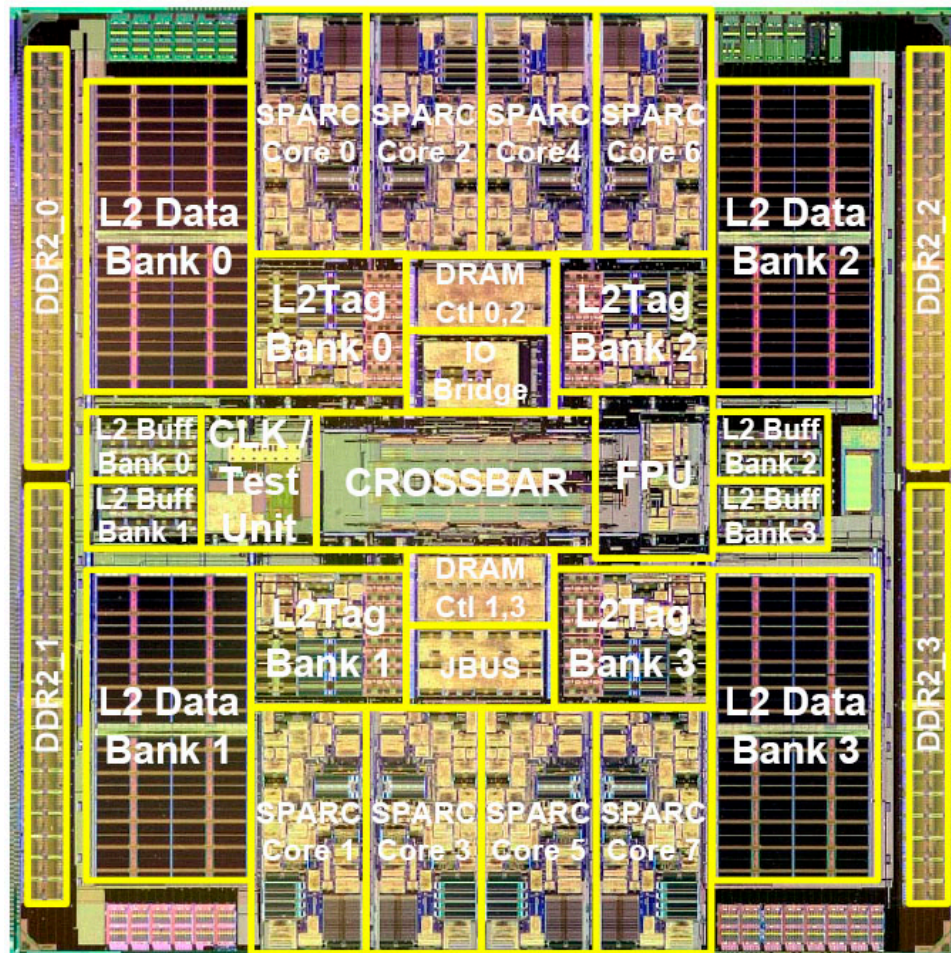

- CCX – Crossbar
- CCU – Clock control
- DMU/PEU – PCI Express
- EFU – Efuse for redundancy
- ESR – Ethernet SERDES
- FSR – FBD SERDES
- L2B – L2 write-back buffers
- L2D – L2 data arrays
- L2T – L2 tag arrays
- MCU – Memory controller
- MIO – Miscellaneous I/O
- PSR – PCI Express SERDES
- RDP/TDS/RTX/MAC – Ethernet
- SII/SIO – I/O data path to and from memory
- SPC – SPARC cores
- TCU – Test and control unit

Multiprocessors

- Multiple hardware processors: each executes a series of **processes** (software constructs) modeling sequential programs
- Multicore architecture: multiple processors are placed on the same **chip**

Principles of an architecture

- Two fundamental components that **fall apart: processors and memory**
- The Interconnect links the processors with the memory:
 - **SMP** (symmetric): bus (a tiny Ethernet)
 - **NUMA** (network): point-to-point network

Cycles

- The basic unit of time is the **cycle**: time to execute a local instruction
- This changes with technology but the relative **cost** of instructions (local vs shared) does not

Abstract view

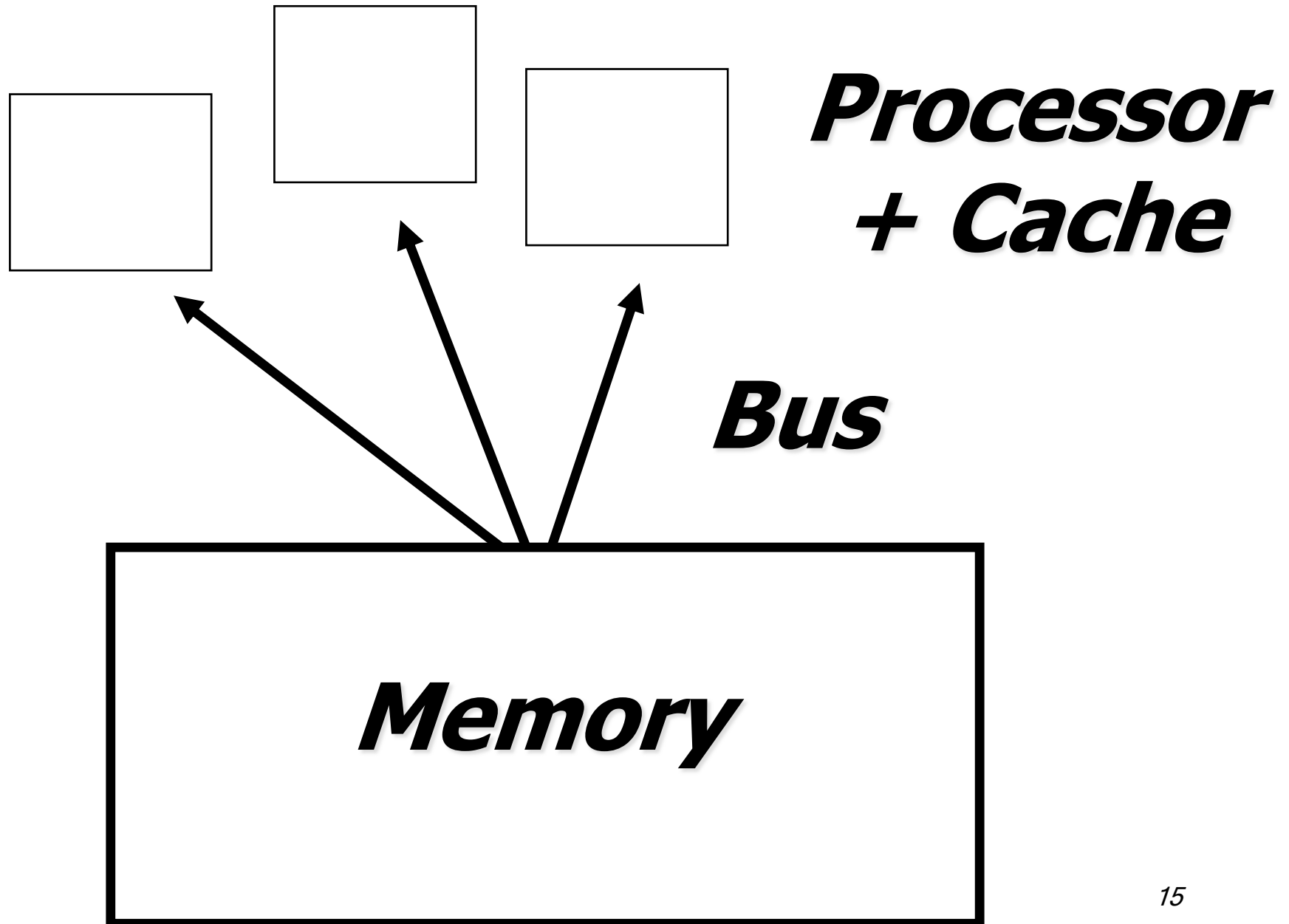

Hardware synchronization objects

- The basic unit of communication is the **read** and **write** to the memory (through the cache)
- More sophisticated objects are typically provided and, as we will see, necessary: **C&S**, **T&S**, **LL/SC**

The free ride is over

- Cannot rely on CPUs getting faster in every generation
- Utilizing more than one CPU core requires concurrency

The free ride is over

- ☞ One of the biggest software challenges:
exploiting concurrency
 - Every programmer will have to deal with it
 - Concurrent programming is hard to get right

Speed will be achieved by having several processors work on independent parts of a task

But

the processors would occasionally need to pause and synchronize

Concurrent processes

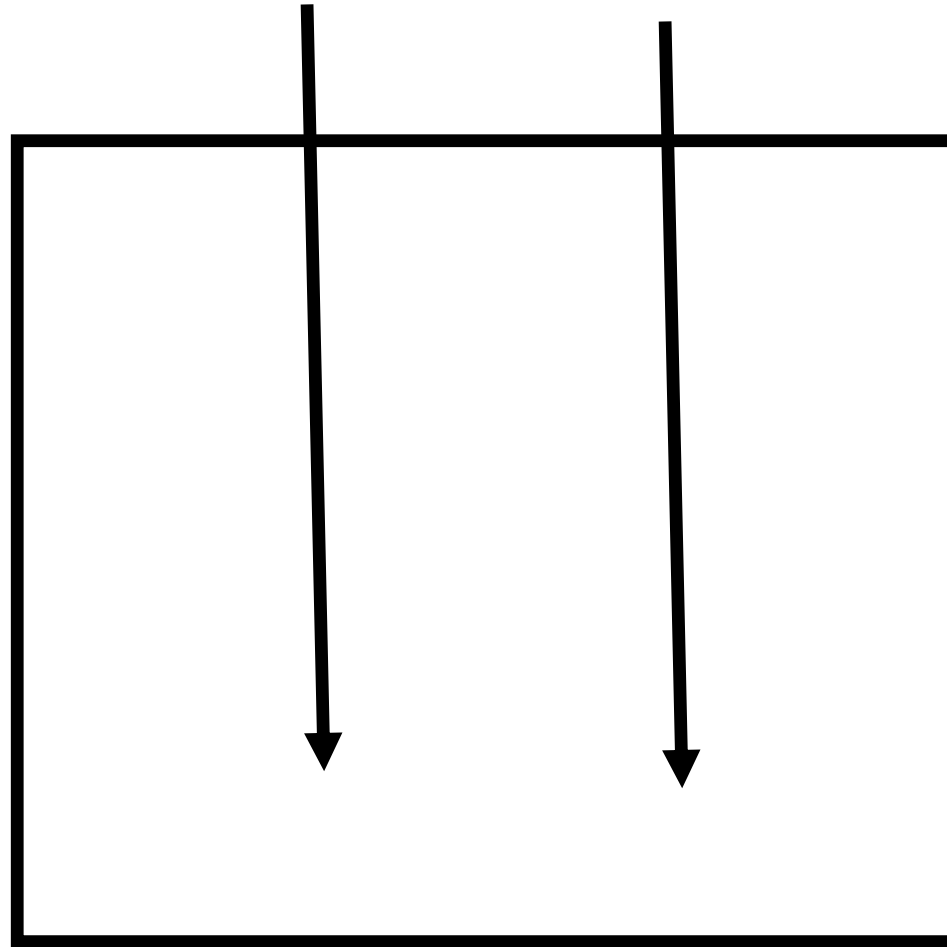

Shared object

Counter

```
public class Counter

private int c = 0;

public long getAndIncrement()
{
return c++;
}
```

Locking (mutual exclusion)

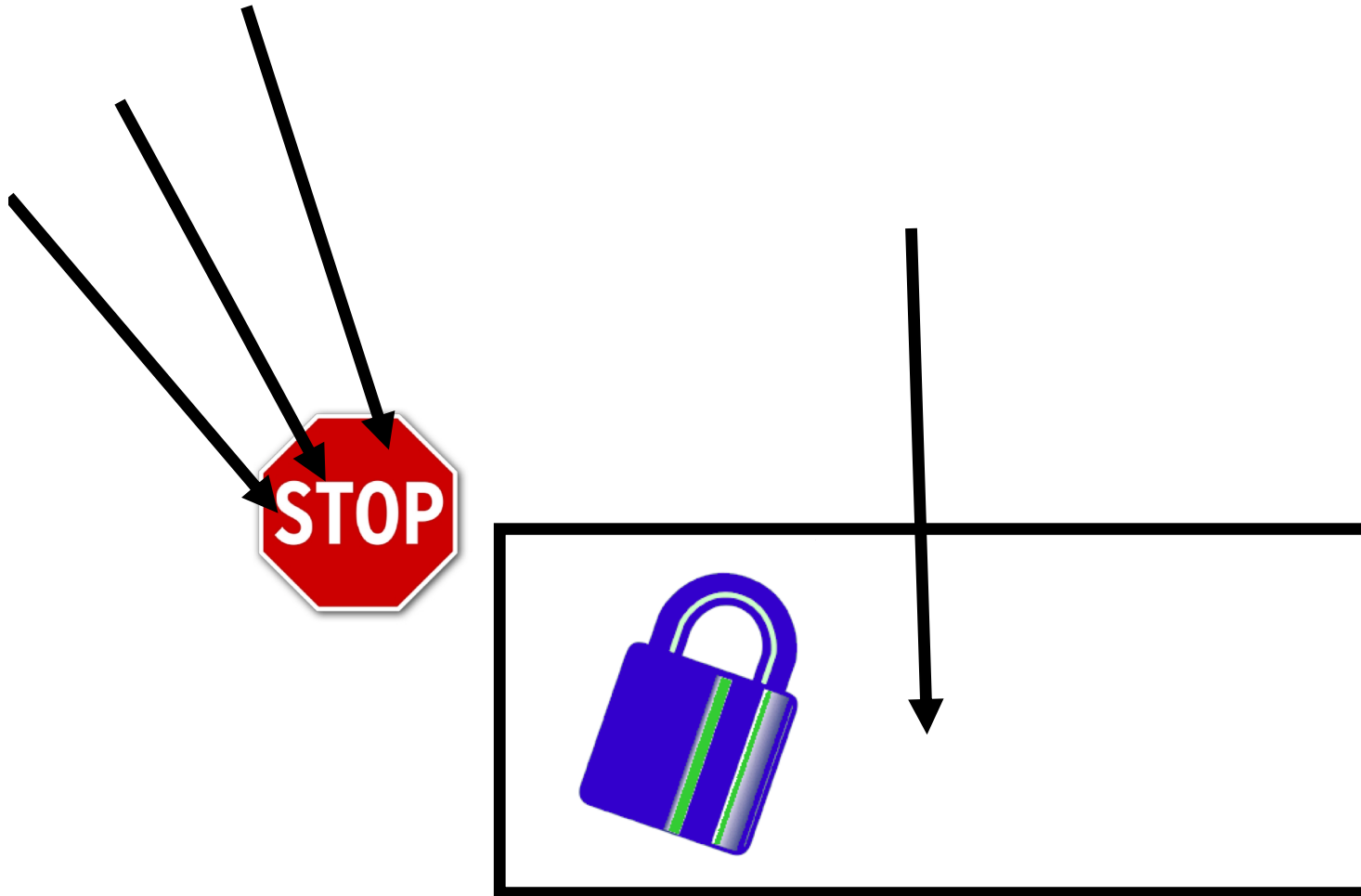

Locked object

Implicit use of a lock

```
public class SynchronizedCounter {  
    private int c = 0;  
    public synchronized void increment() {  
        c++;  
    }  
    public synchronized void getAndincrement()  
{  
        return c++;  
    }  
    public synchronized int value() {  
        return c;  
    }  
}
```

Locking with `compare&swap()`

- A ***Compare&Swap*** object maintains a value x , init to \perp , and y ;
- It provides one operation: ***c&s(old,new)***;
 - ✓ Sequential spec:
 - `c&s(old,new)`
`{y := x; if x = old then x := new; return(y)}`

Locking with compare&swap()

```
lock() {  
  repeat until  
  unlocked = this.c&s(unlocked, locked)  
}
```

```
unlock() {  
  this.c&s(locked, unlocked)  
}
```

Locking with `test&set()`

- A *Test&Set* object maintains binary values `x`, init to 0, and `y`;
- It provides one operation: *t&s()*
 - ✓ Sequential spec:
 - ✓ `t&s() {y := x; x: = 1; return(y);}`

Locking with test&set()

```
lock() {  
    repeat until (0 = this.t&s());  
}
```

```
unlock() {  
    this.setState(0);  
}
```

Locking with test&set()

```
lock() {  
while (true)  
{  
repeat until (0 = this.getState());  
if 0 = (this.t&s()) return(true);  
}  
}
```

```
unlock() {  
    this.setState(0);  
}
```

Explicit use of a lock

```
Lock l = ...;  
    l.lock();  
    try {  
// access the resource protected by this lock  
    } finally {  
        l.unlock();  
    }  
}
```

Locking (mutual exclusion)

- ☛ **Difficult:** 50% of the bugs reported in Java come from the mis-use of « synchronized »
- ☛ **Slow:** a process holding a lock prevents all others from progressing

Locked object

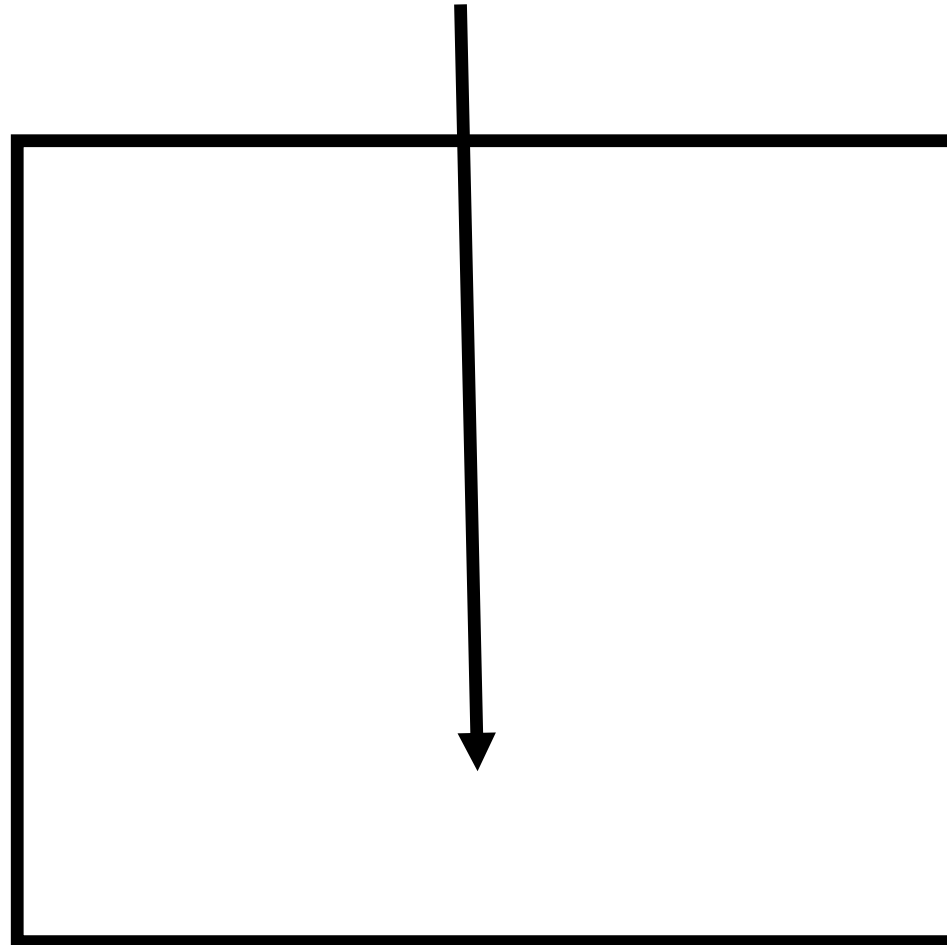

One process at a time

Processes are asynchronous

- *Page faults*
- *Pre-emptions*
- *Failures*
- *Cache misses, ...*

Processes are asynchronous

- ☛ A cache miss can delay a process by ten instructions
- ☛ A page fault by few millions
- ☛ An os preemption by hundreds of millions...

Coarse grained locks => slow

Fine grained locks => errors

Processes are asynchronous

- *Page faults, pre-emptions, failures, cache misses, ...*
- A process can be delayed by millions of instructions ...

Alternative to locking?

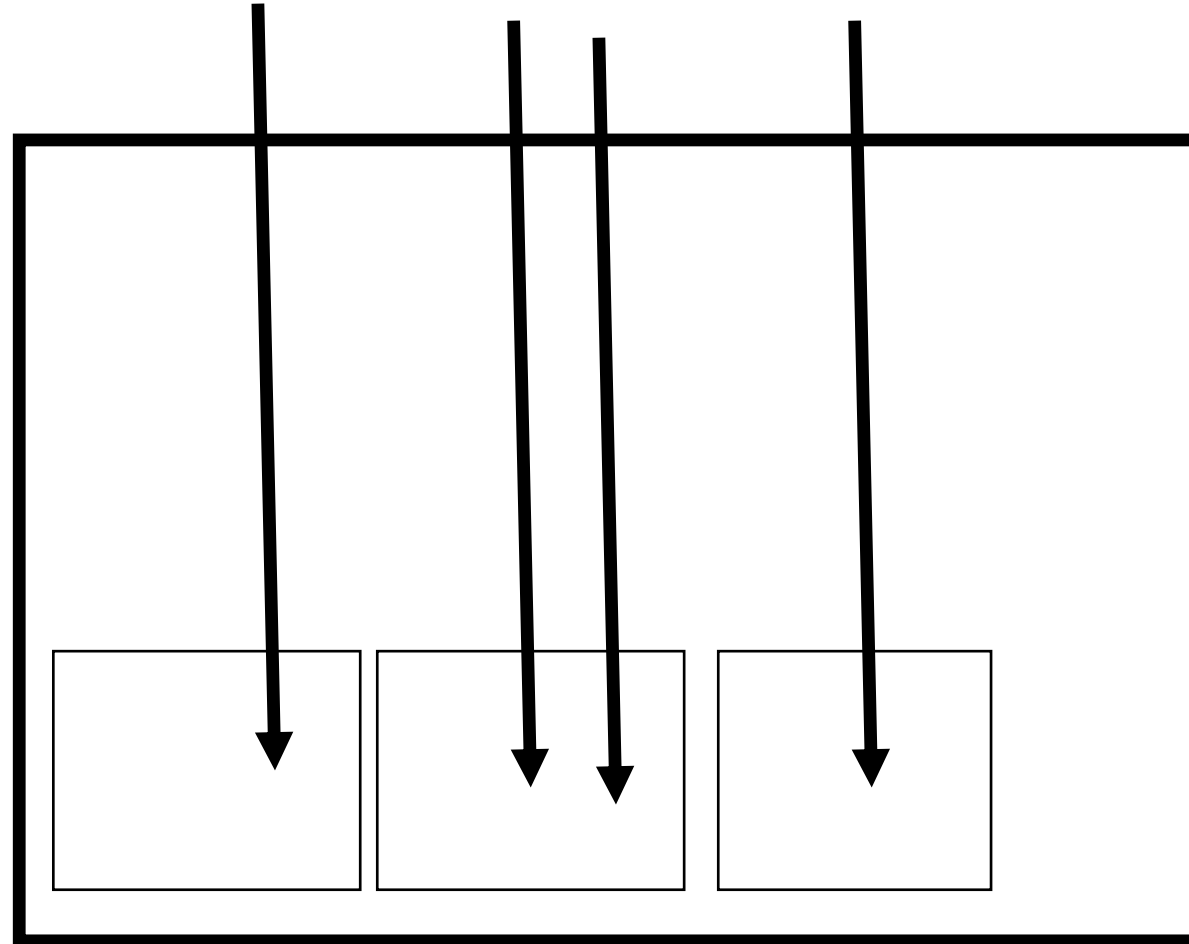

Wait-free atomic objects

- ***Wait-freedom:*** every process that invokes an operation eventually returns from the invocation (robust ... unlike locking)
- ***Atomicity:*** every operation appears to execute instantaneously (as if the object was locked...)

In short

This course studies how to
wait-free implement high-level
atomic objects out of primitive base objects

Concurrent processes

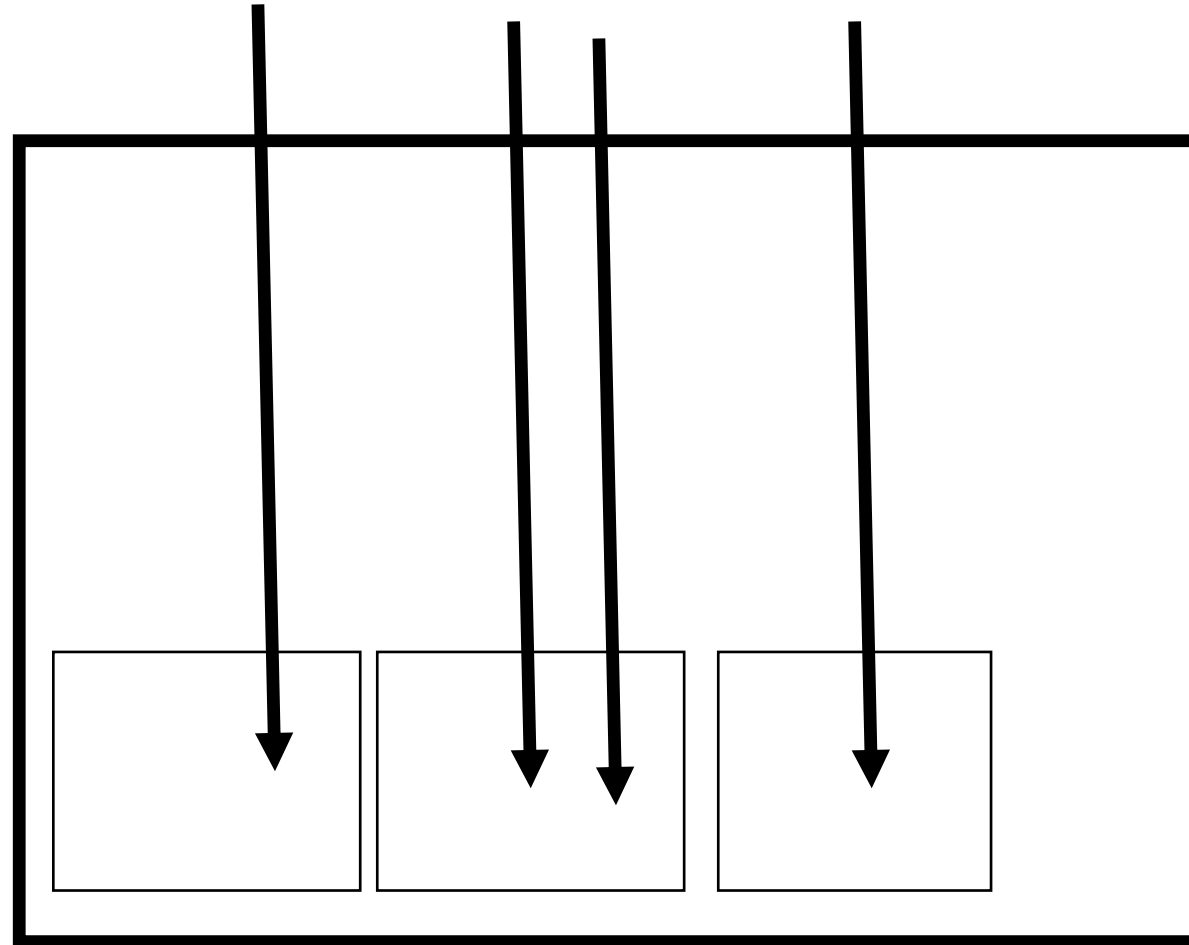

Shared object

Roadmap

- *Model*
 - *Processes and objects*
 - *Atomicity and wait-freedom*
- *Examples*
- *Content*

Processes

- We assume a finite set of processes
- Processes are denoted by p_1, \dots, p_N or p, q, r
- Processes have unique identities and know each other (unless explicitly stated otherwise)

Processes

- Processes are **sequential** units of computations
- Unless explicitly stated otherwise, we make no assumption on process (relative) speeds

Processes

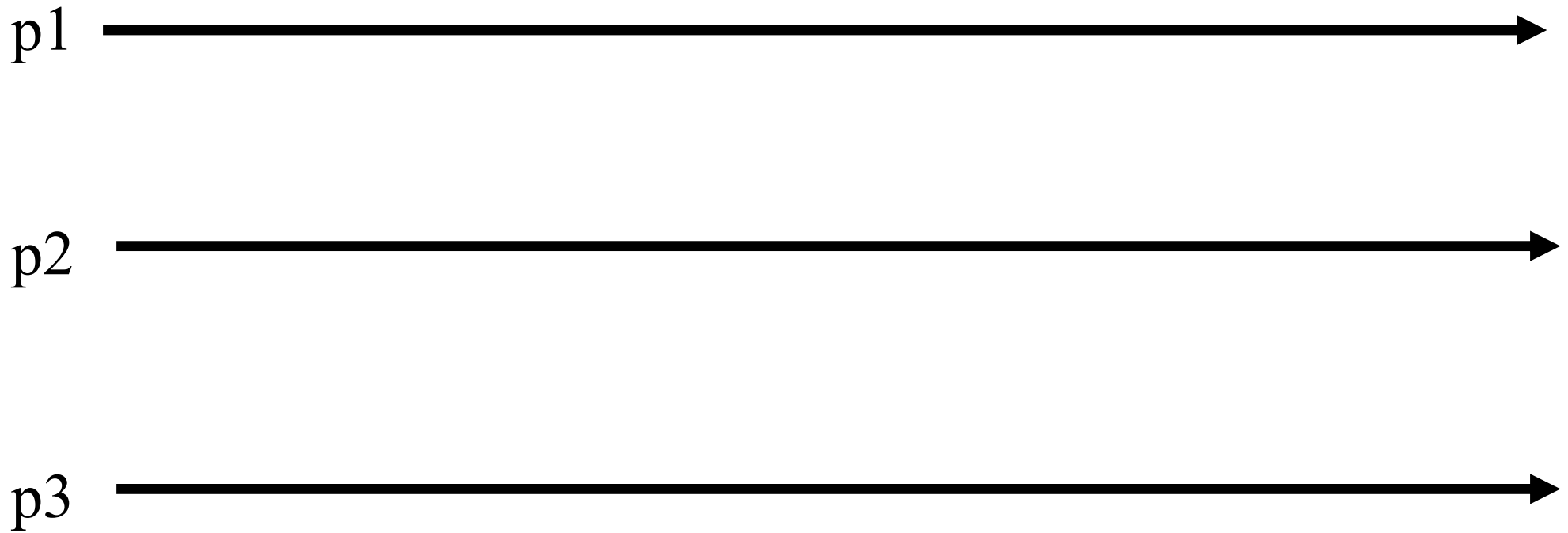

Processes

- A process either executes the algorithm assigned to it or crashes
- A process that crashes does not recover (in the context of the considered computation)
- A process that does not crash in a given execution (computation or run) is called **correct** (in that execution)

Processes

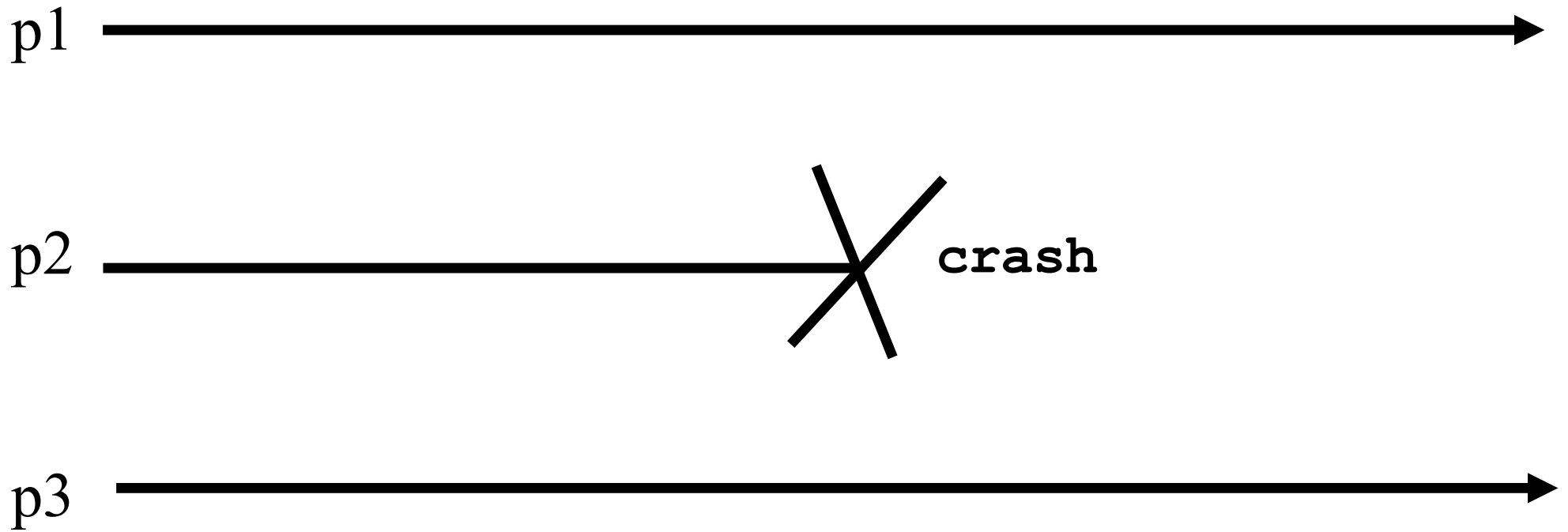

On objects and processes

- Processes execute local computation or access shared objects through their *operations*
- Every operation is expected to return a reply

Processes

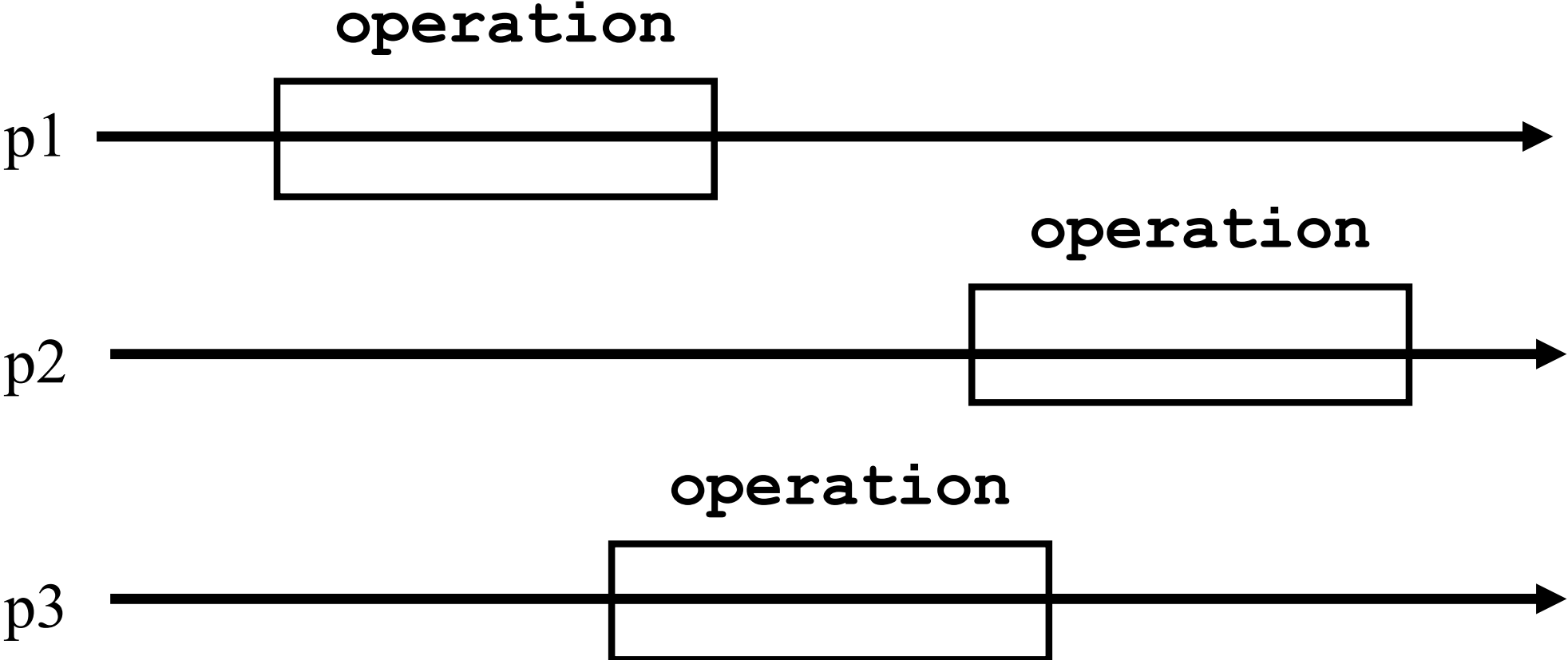

On objects and processes

- ***Sequentiality*** means here that, after invoking an operation op_1 on some object O_1 , a process does not invoke a new operation (on the same or on some other object) until it receives the reply for op_1
- ***Remark.*** Sometimes we talk about operations when we should be talking about operation invocations

Processes

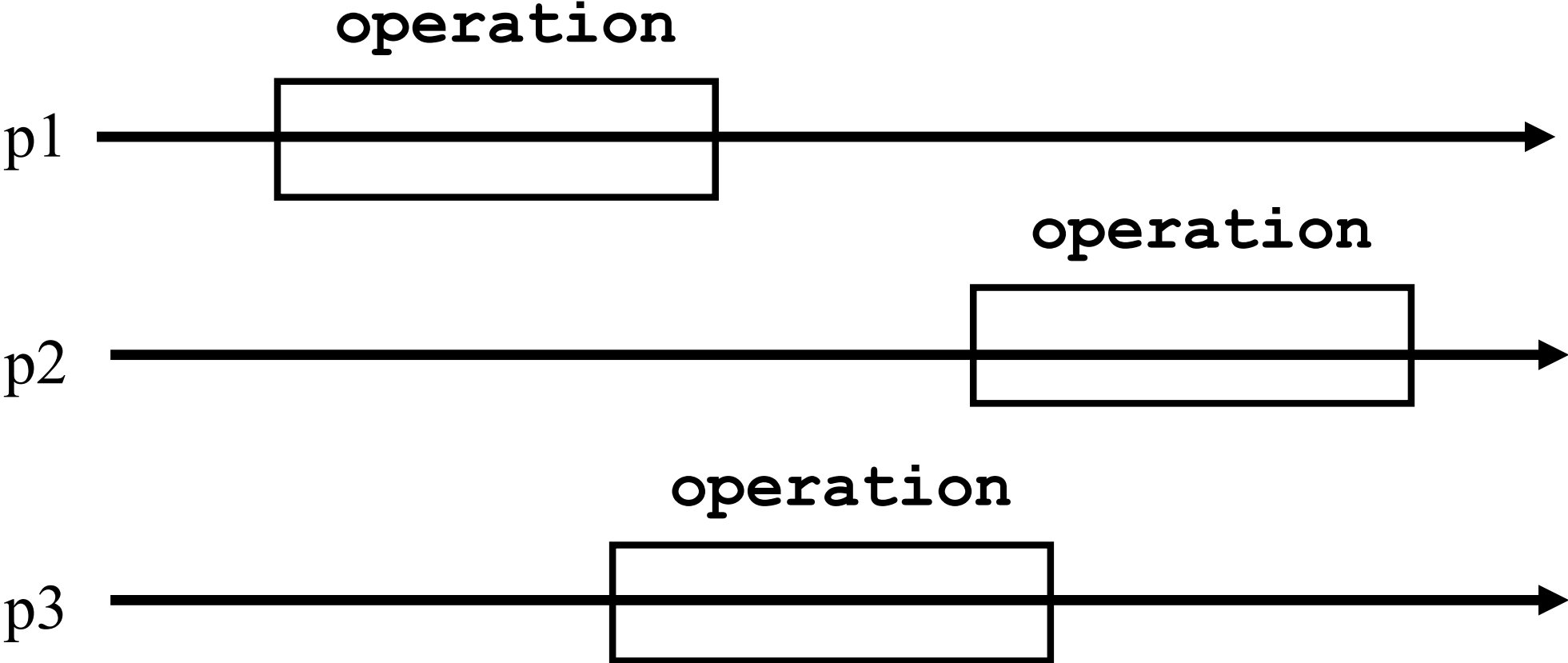

Atomicity

- Every operation appears to execute at some indivisible point in time (called **linearization point**) between the invocation and reply time events

Atomicity

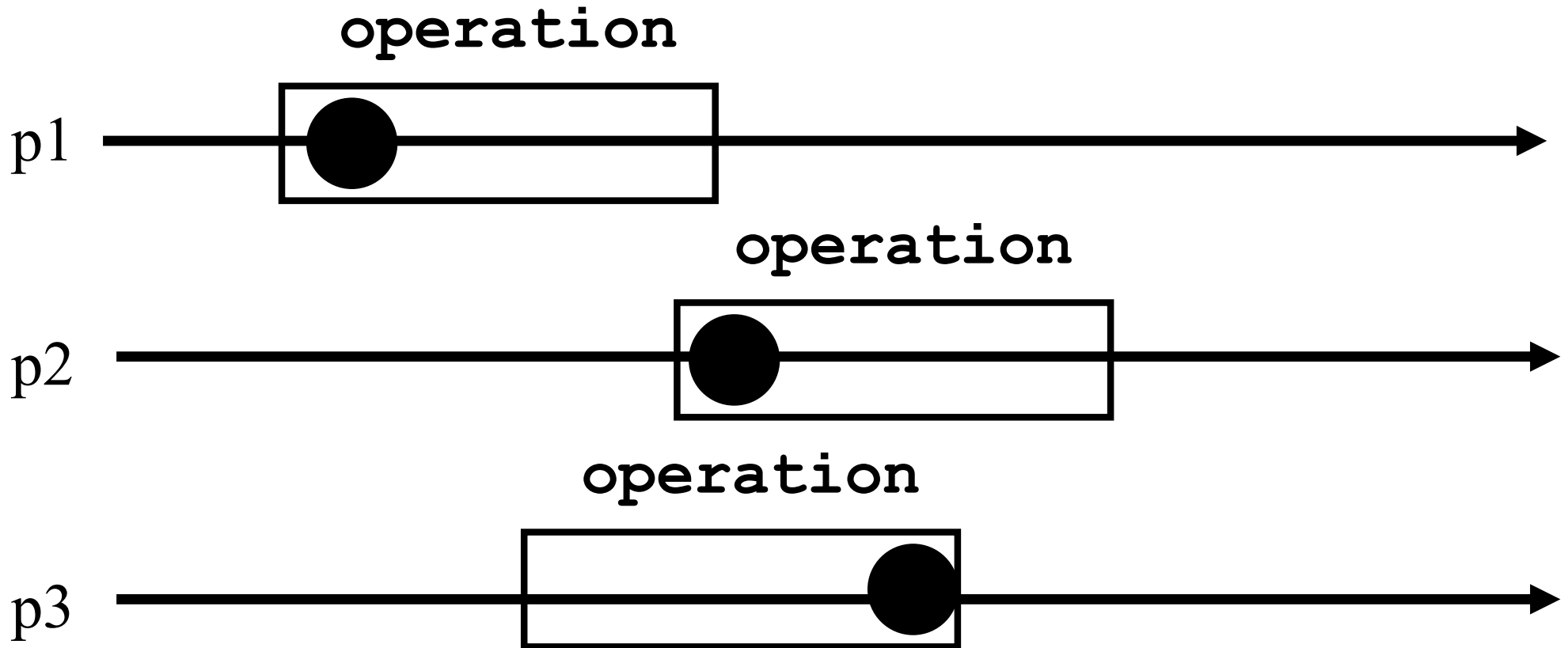

Atomicity

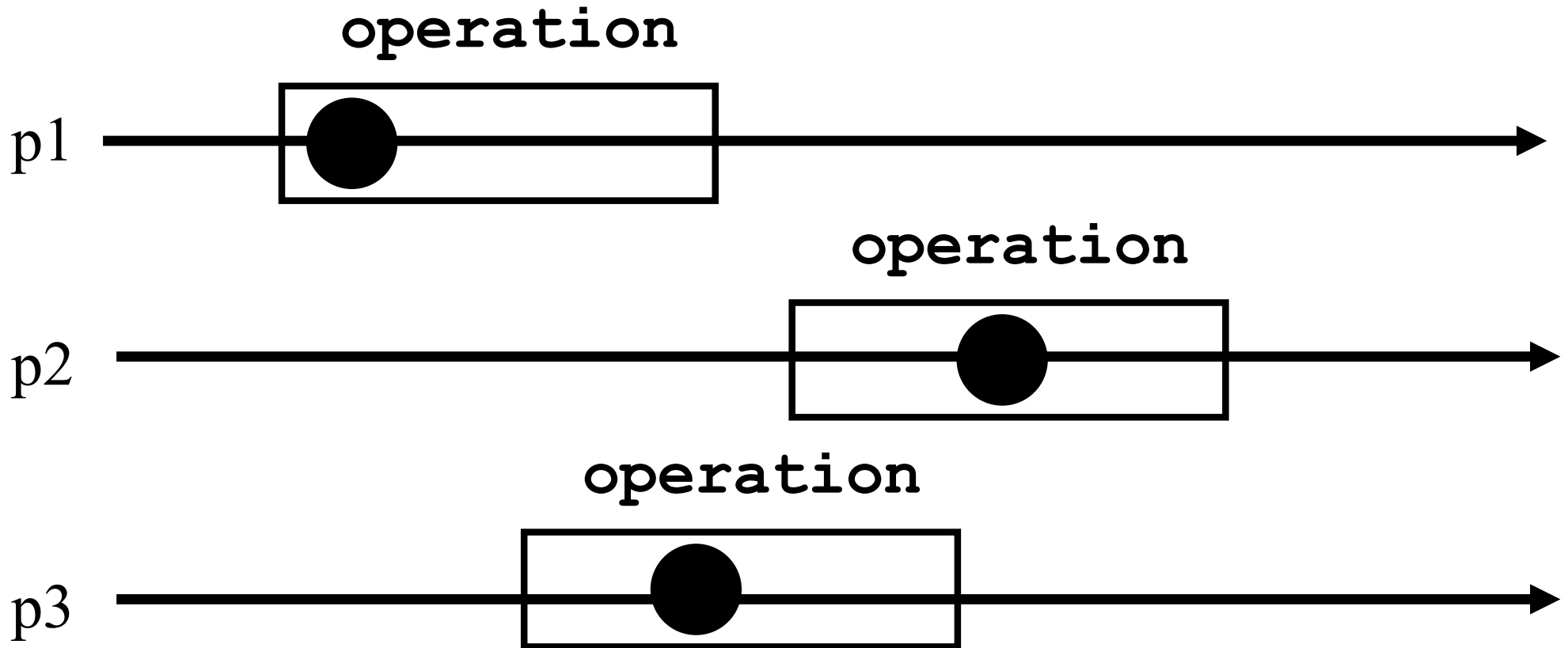

Atomicity (the crash case)

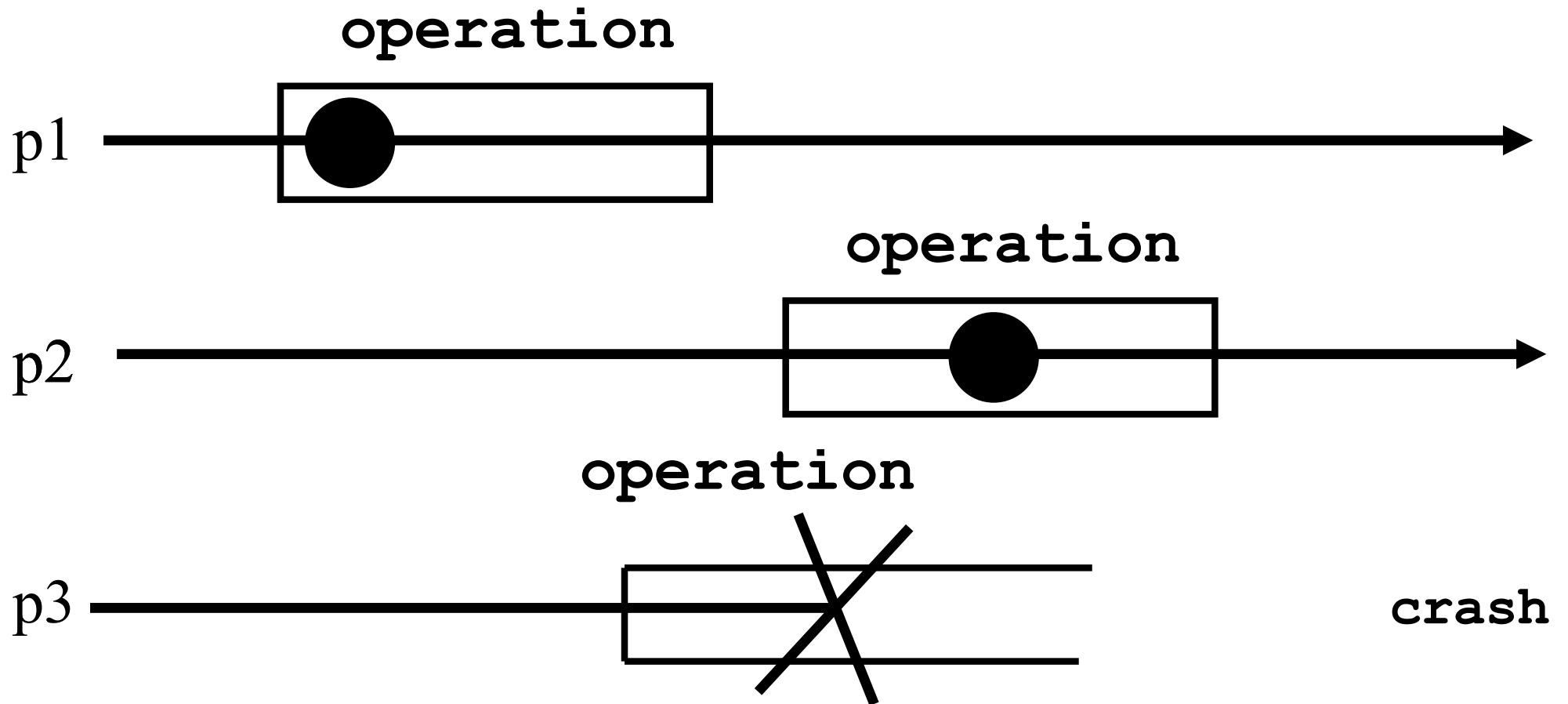

Atomicity (the crash case)

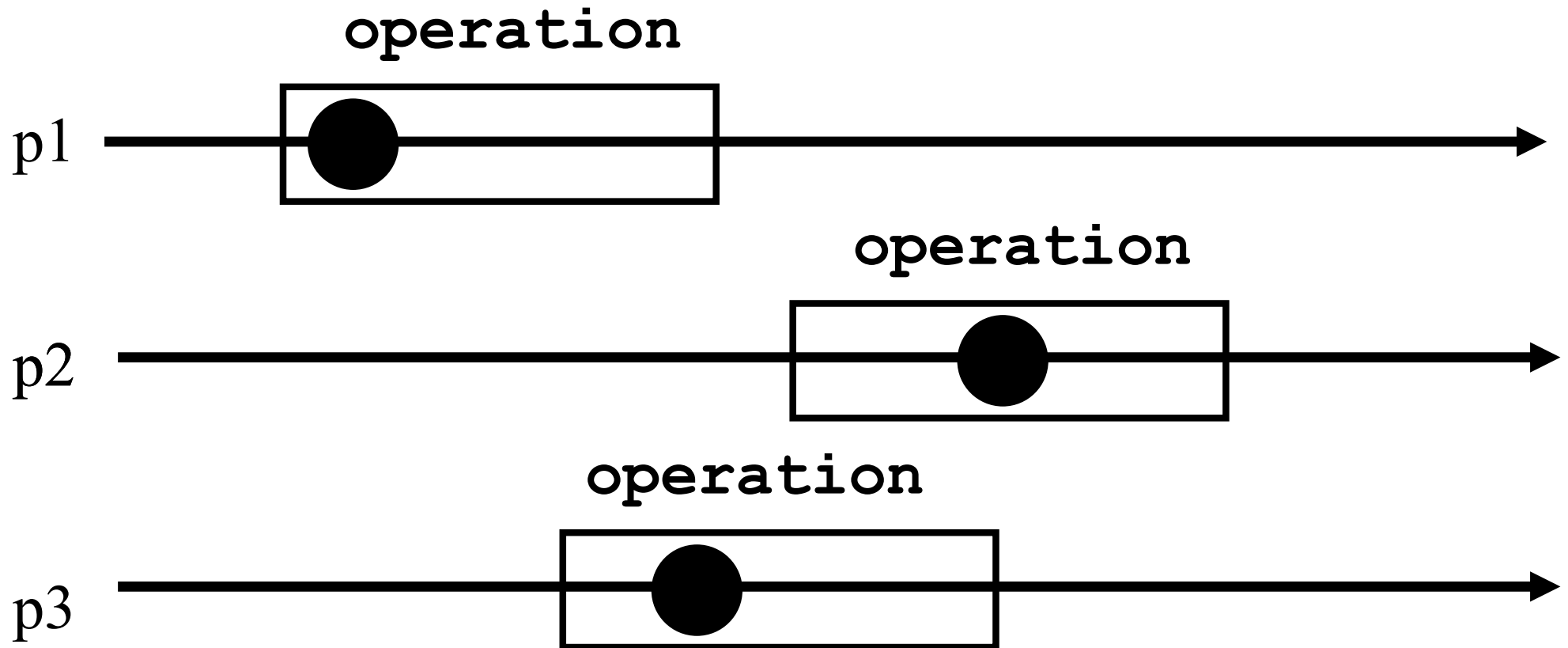

Atomicity (the crash case)

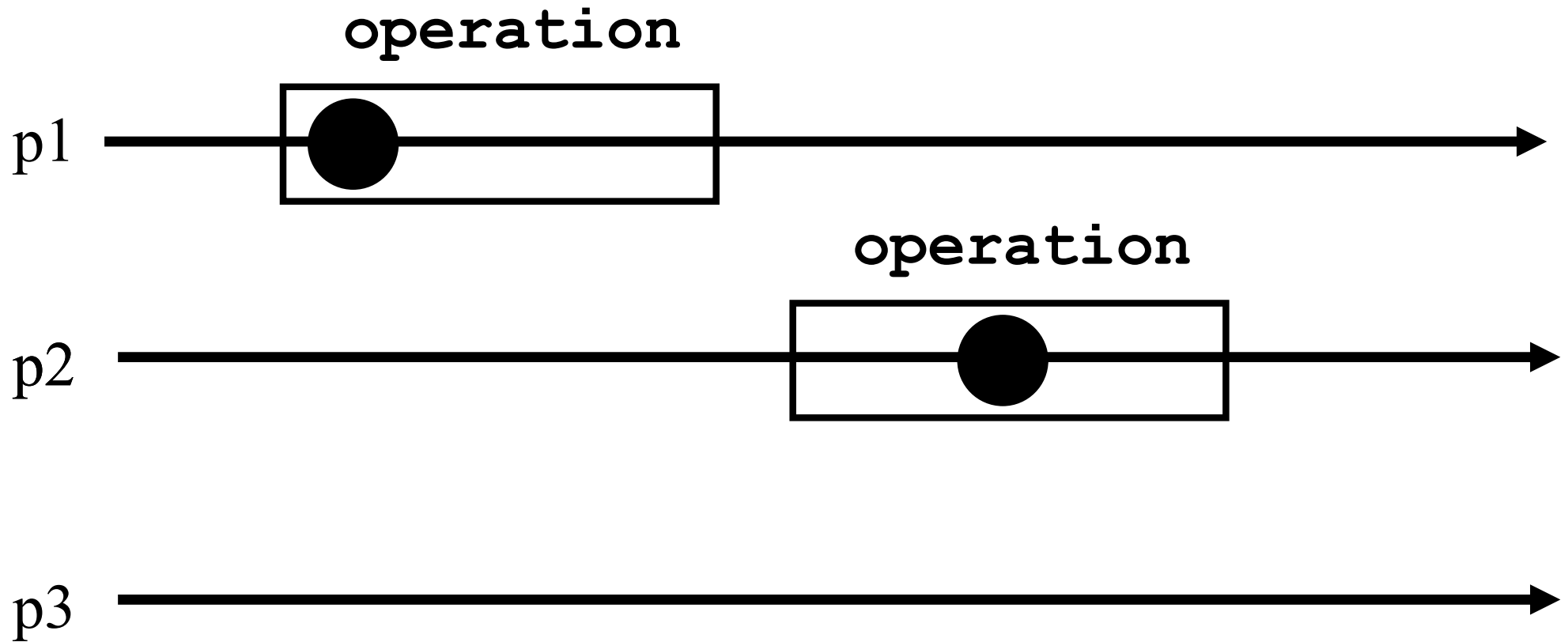

Wait-freedom

- Any correct process that invokes an operation eventually gets a reply, no matter what happens to the other processes (very slow or crash)

Wait-freedom

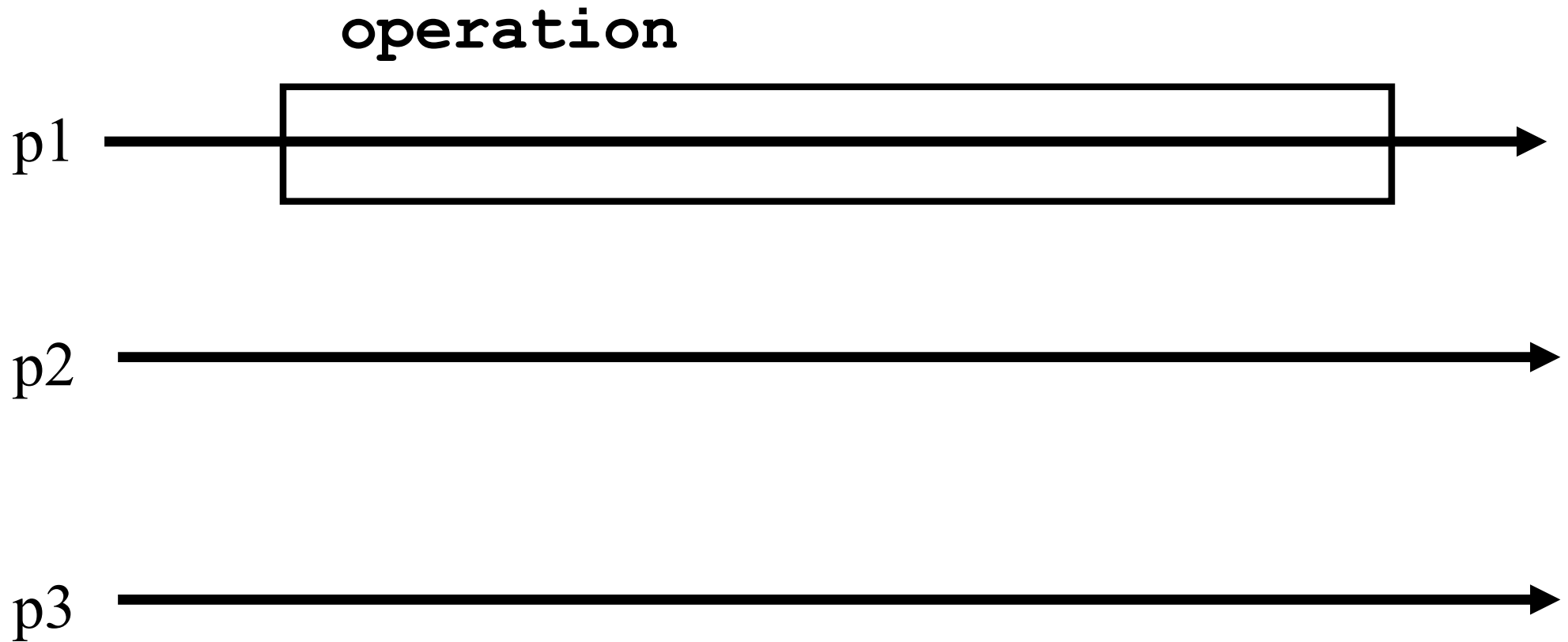

Wait-freedom

- ☛ Wait-freedom conveys the robustness of the implementation
- ☛ With a wait-free implementation, a process gets replies despite the crash of the $n-1$ other processes
- ☛ Note that this precludes implementations based on locks (mutual exclusion)

Wait-freedom

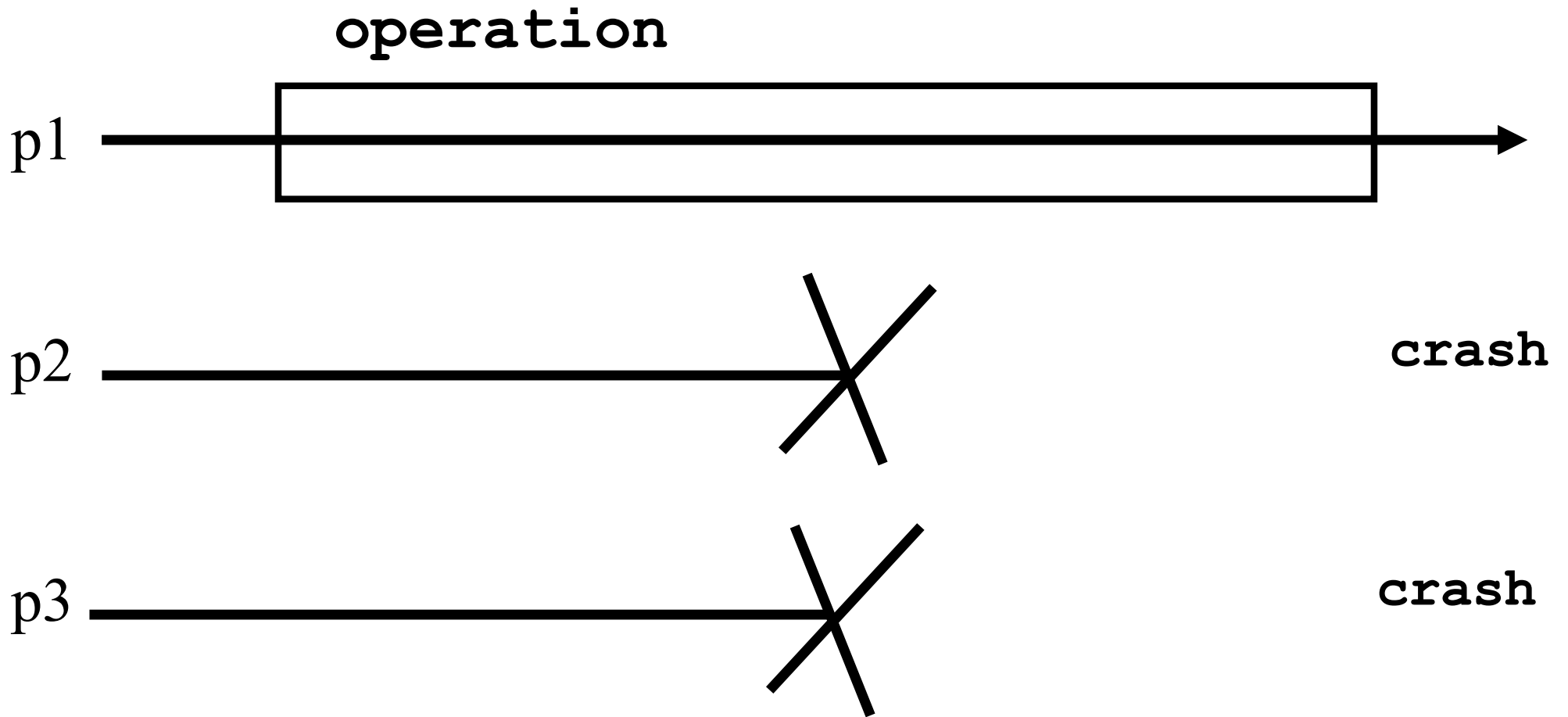

Roadmap

- ☛ Model
 - ☛ Processes and objects
 - ☛ Atomicity and wait-freedom
- ☛ Examples
- ☛ Content

Motivation

- Most synchronization primitives (problems) can be precisely expressed as **atomic objects** (implementations)
- Studying how to ensure robust synchronization boils down to studying **wait-free atomic object** implementations

Example 1

- ☛ The reader/writer synchronization problem corresponds to the *register* object
- ☛ Basically, the processes need to read or write a shared data structure such that the value read by a process at a time t , is the last value written before t

Register

- A *register* has two operations: *read()* and *write()*
- We assume that a *register* contains an integer for presentation simplicity, i.e., the value stored in the *register* is an integer, denoted by x (initially 0)

Sequential specification

- Sequential specification

- read()***

- return(x)

- write(v)***

- x <- v;

- return(ok)

Atomicity?

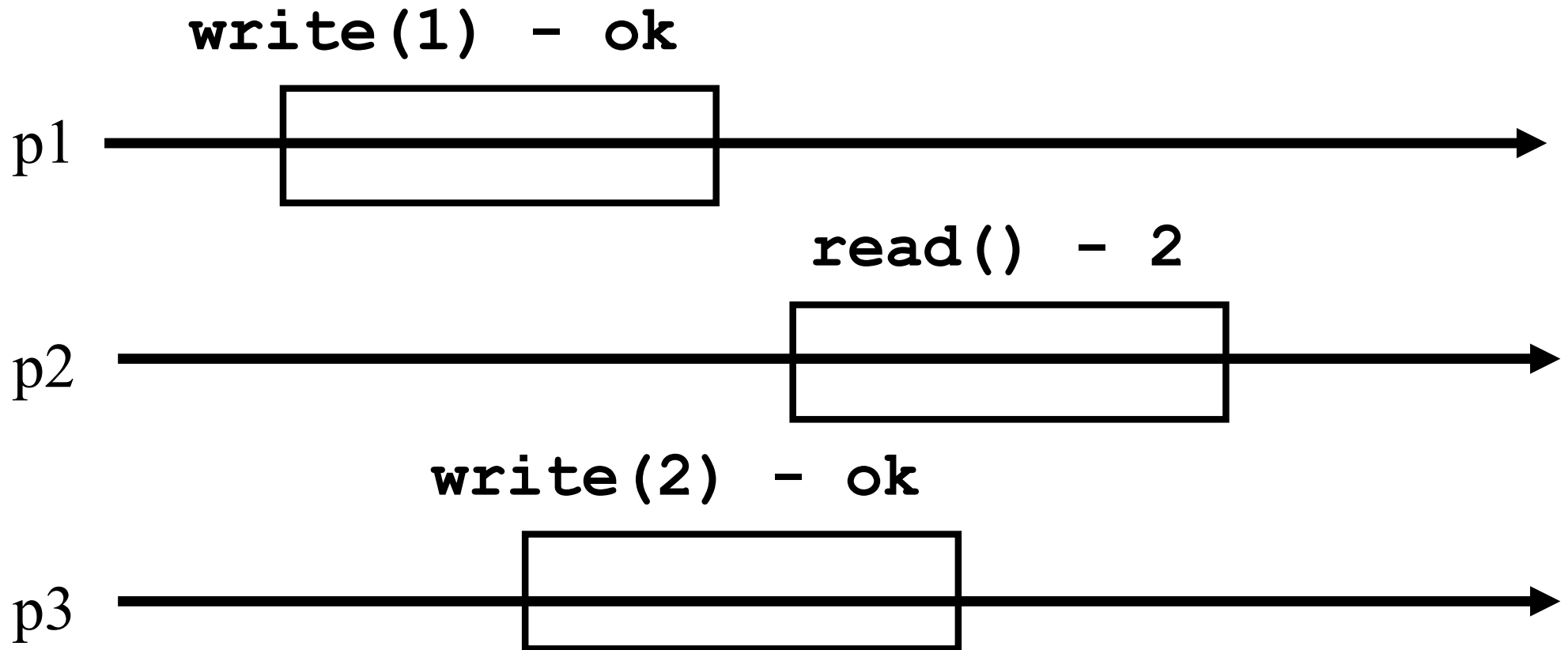

Atomicity?

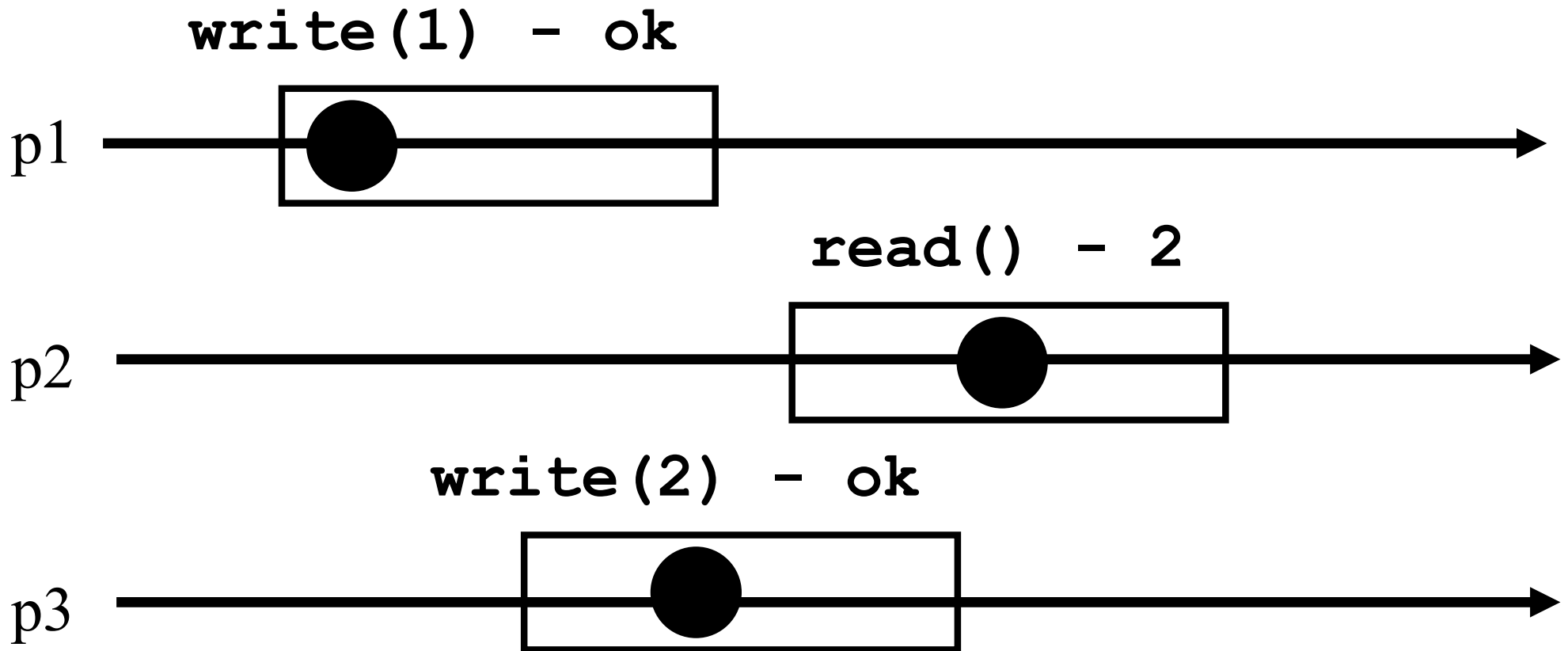

Atomicity?

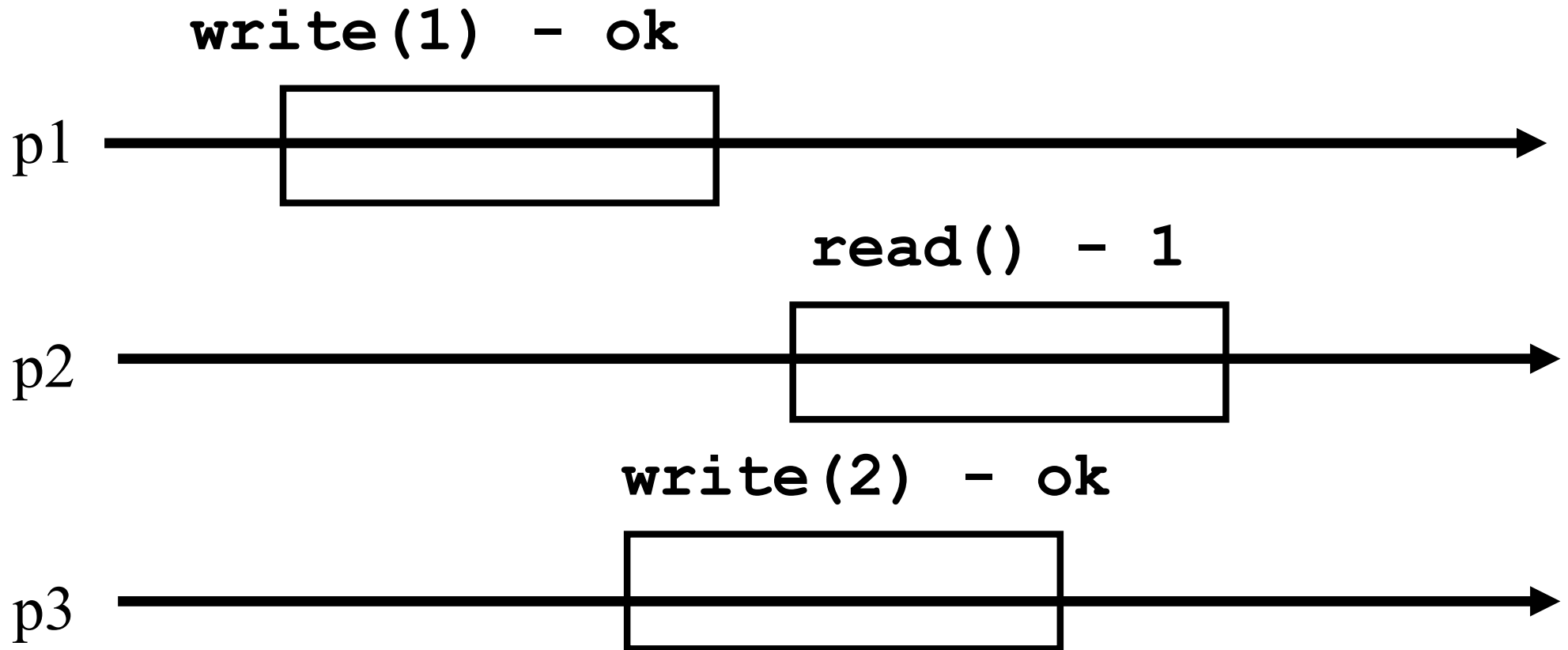

Atomicity?

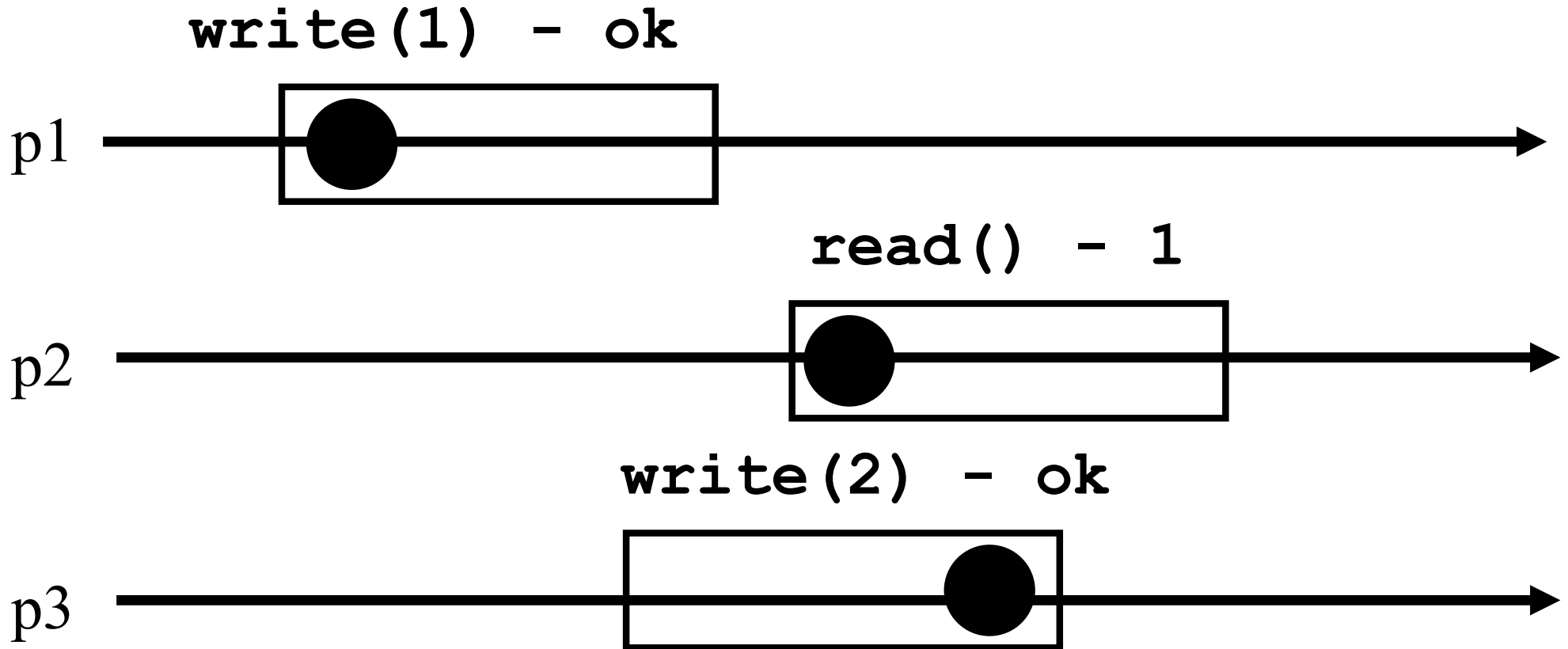

Atomicity?

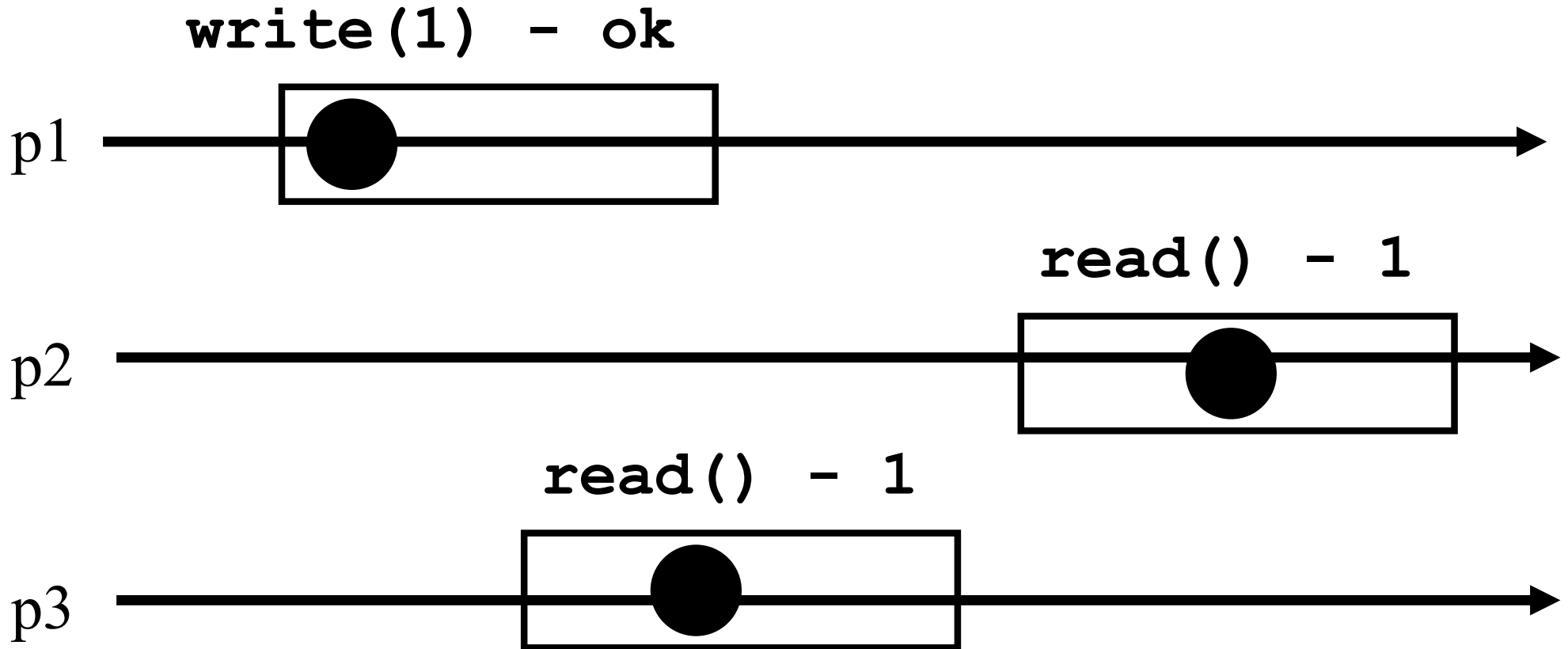

Atomicity?

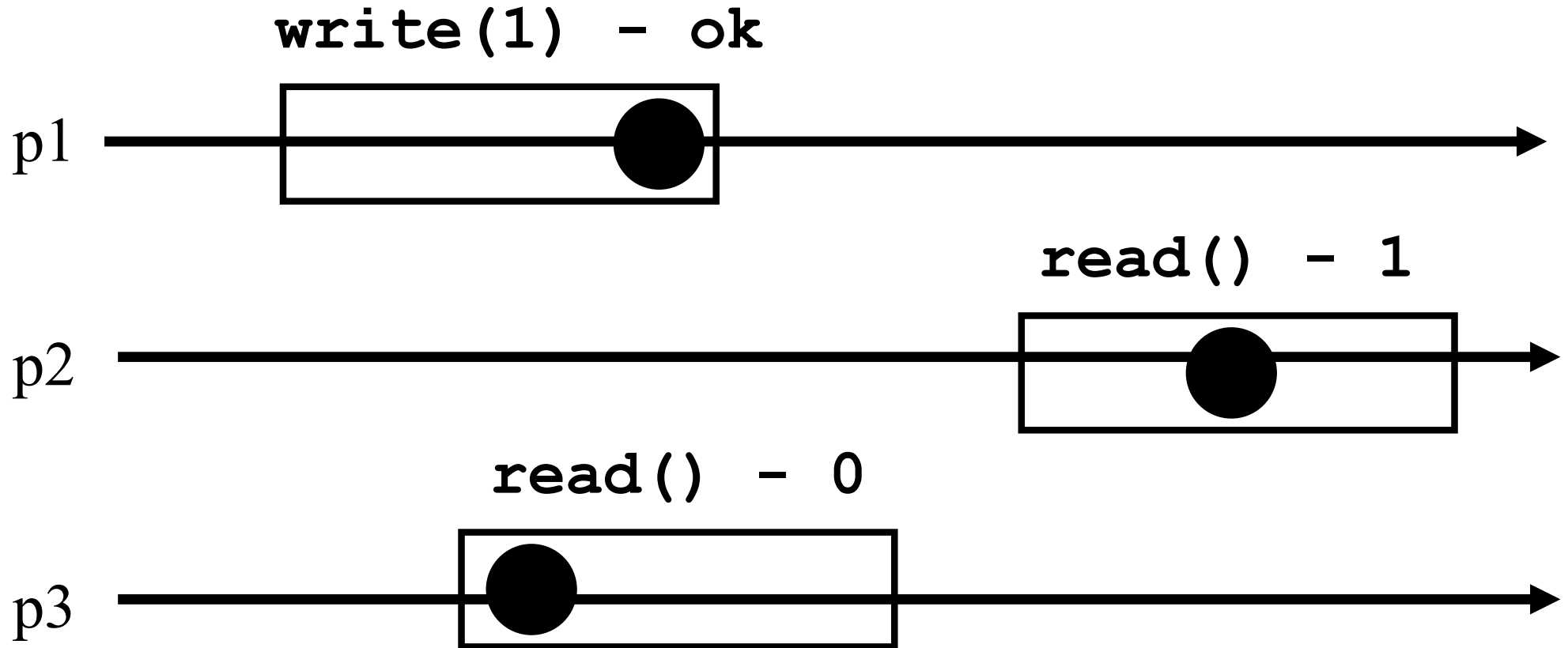

Atomicity?

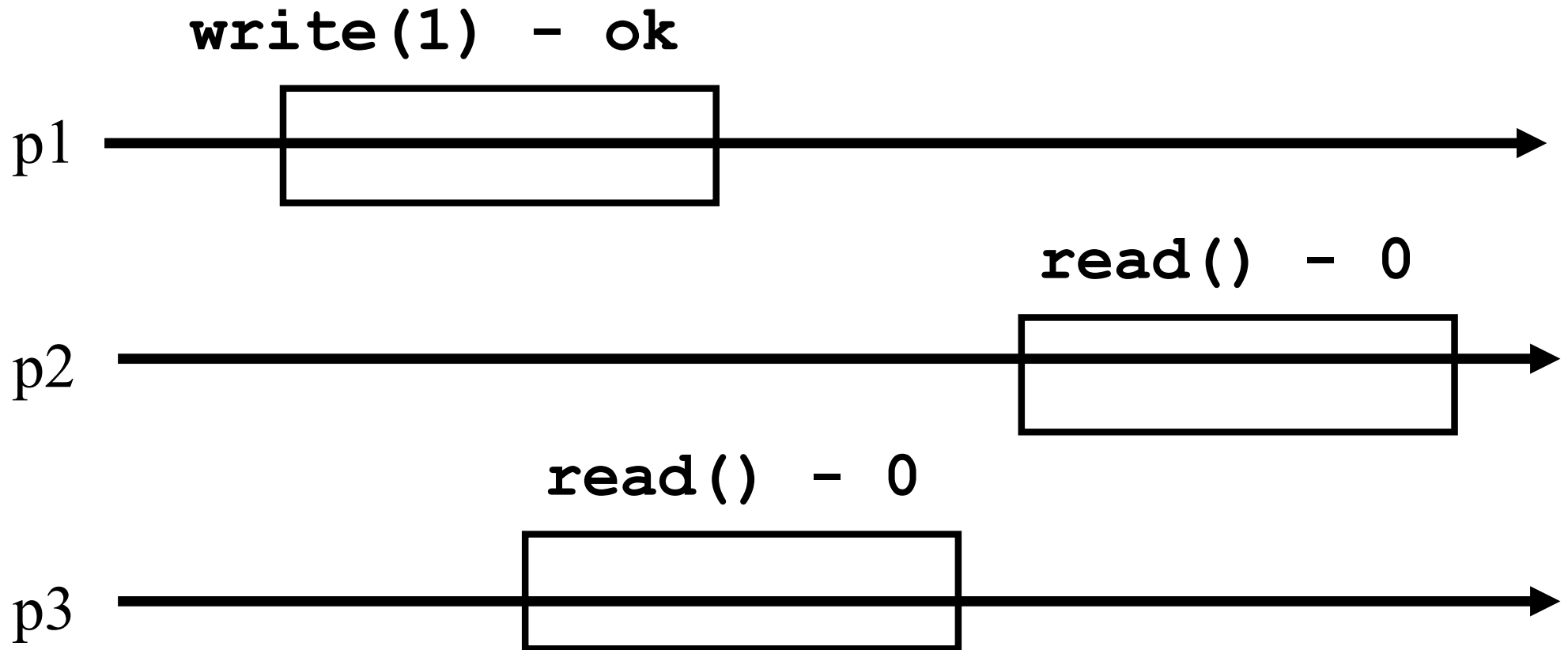

Atomicity?

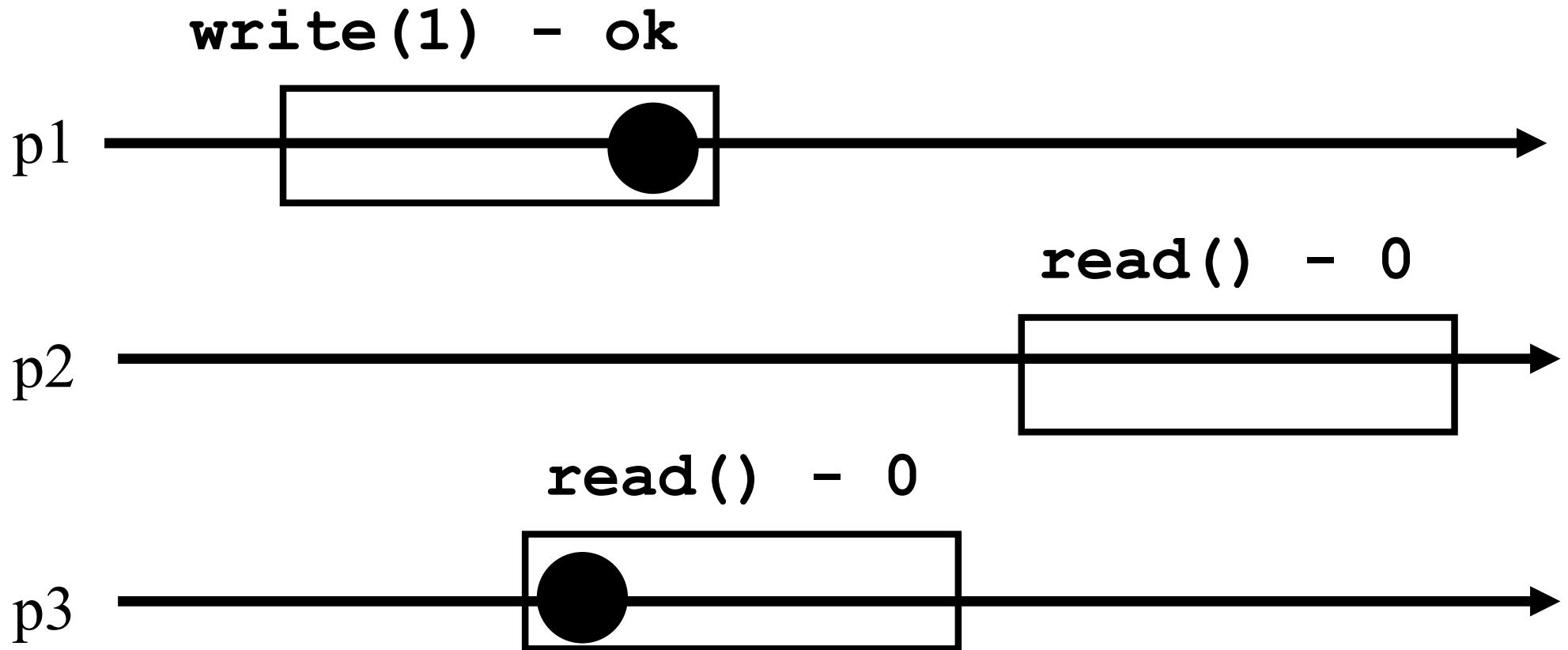

Atomicity?

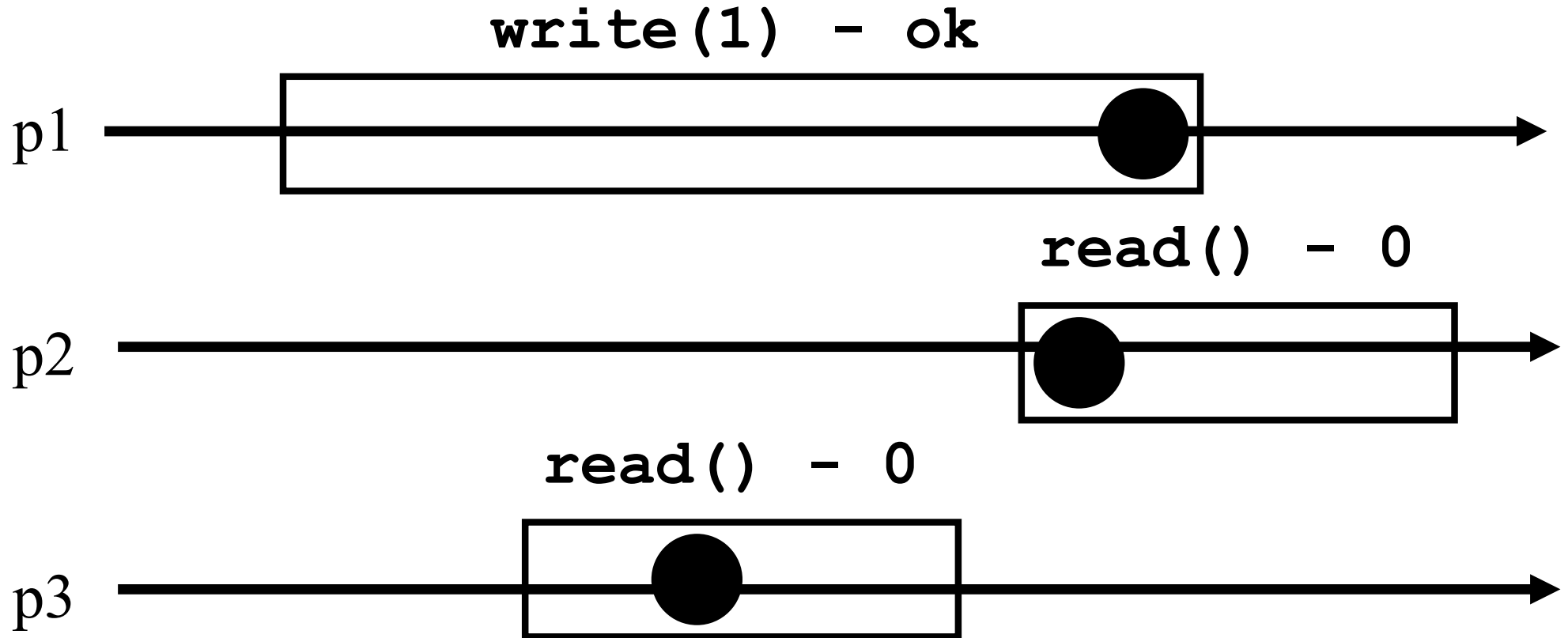

Atomicity?

`write(1) - ok`

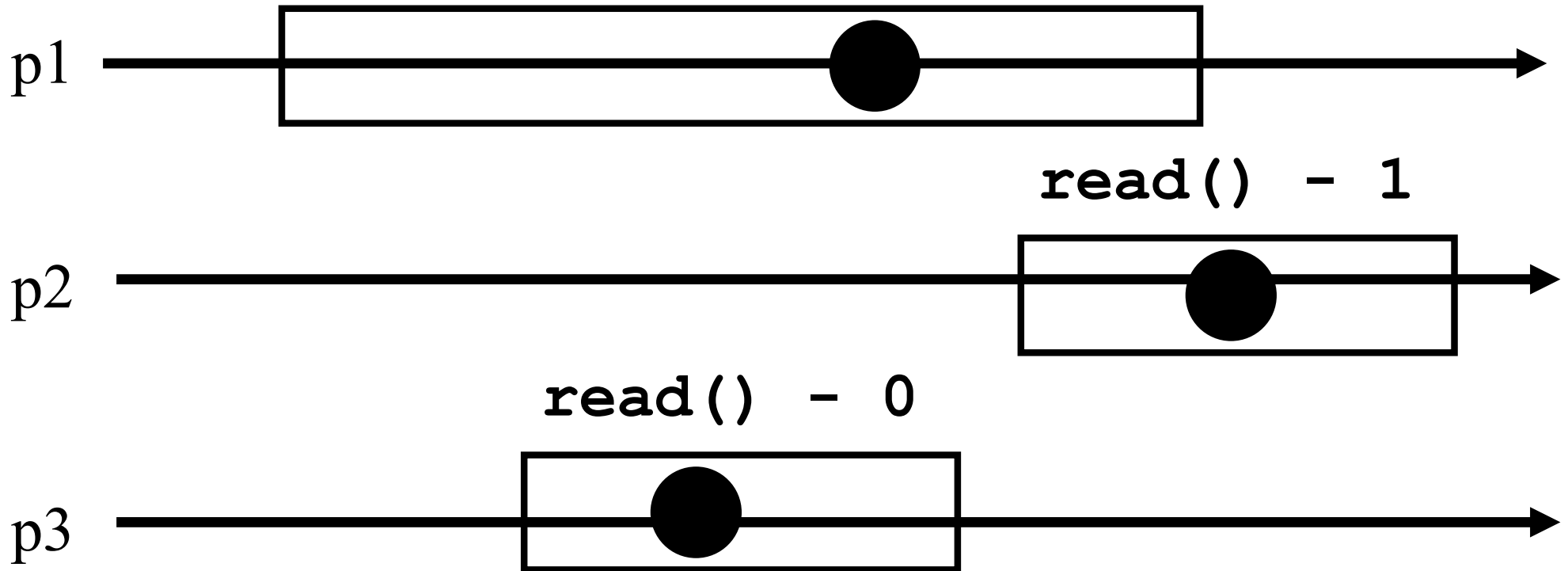

Atomicity?

`write(1) - ok`

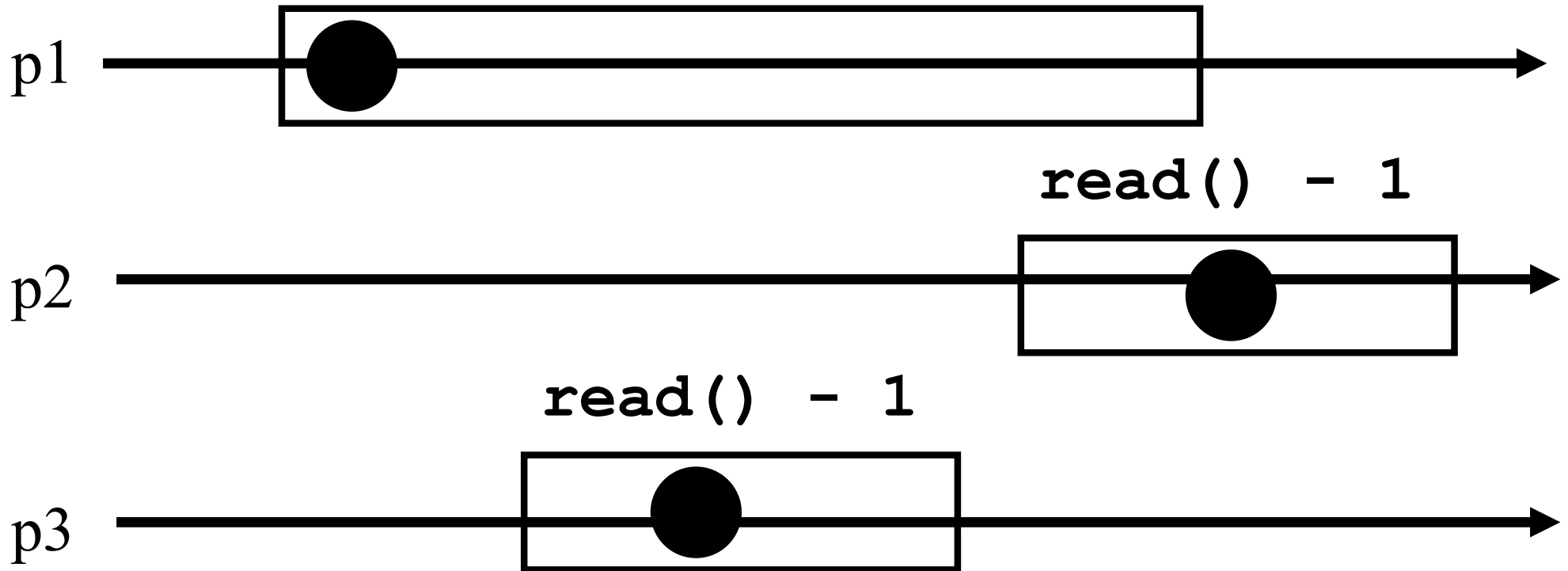

Example 2

- The producer/consumer synchronization problem corresponds to the *queue* object
- Producer processes create items that need to be used by consumer processes
- An item cannot be consumed by two processes and the first item produced is the first consumed

Queue

- A *queue* has two operations: *enqueue()* and *dequeue()*
- We assume that a *queue internally* maintains a list x which exports operation *appends()* to put an item at the end of the list and *remove()* to remove an element from the head of the list

Sequential specification

• *dequeue()*

- if($x=0$) then return(nil);
- else return($x.remove()$)

• *enqueue(v)*

- $x.append(v)$;
- return(ok)

Atomicity?

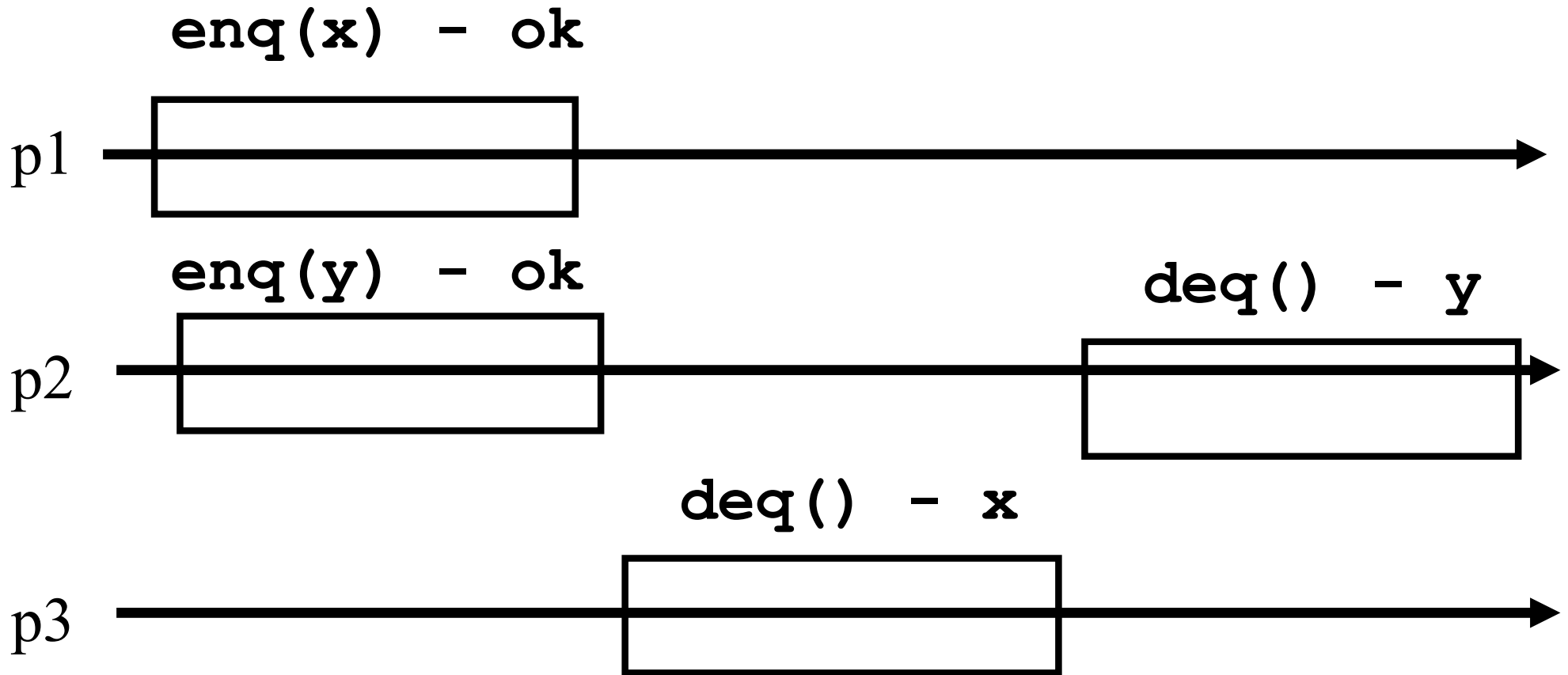

Atomicity?

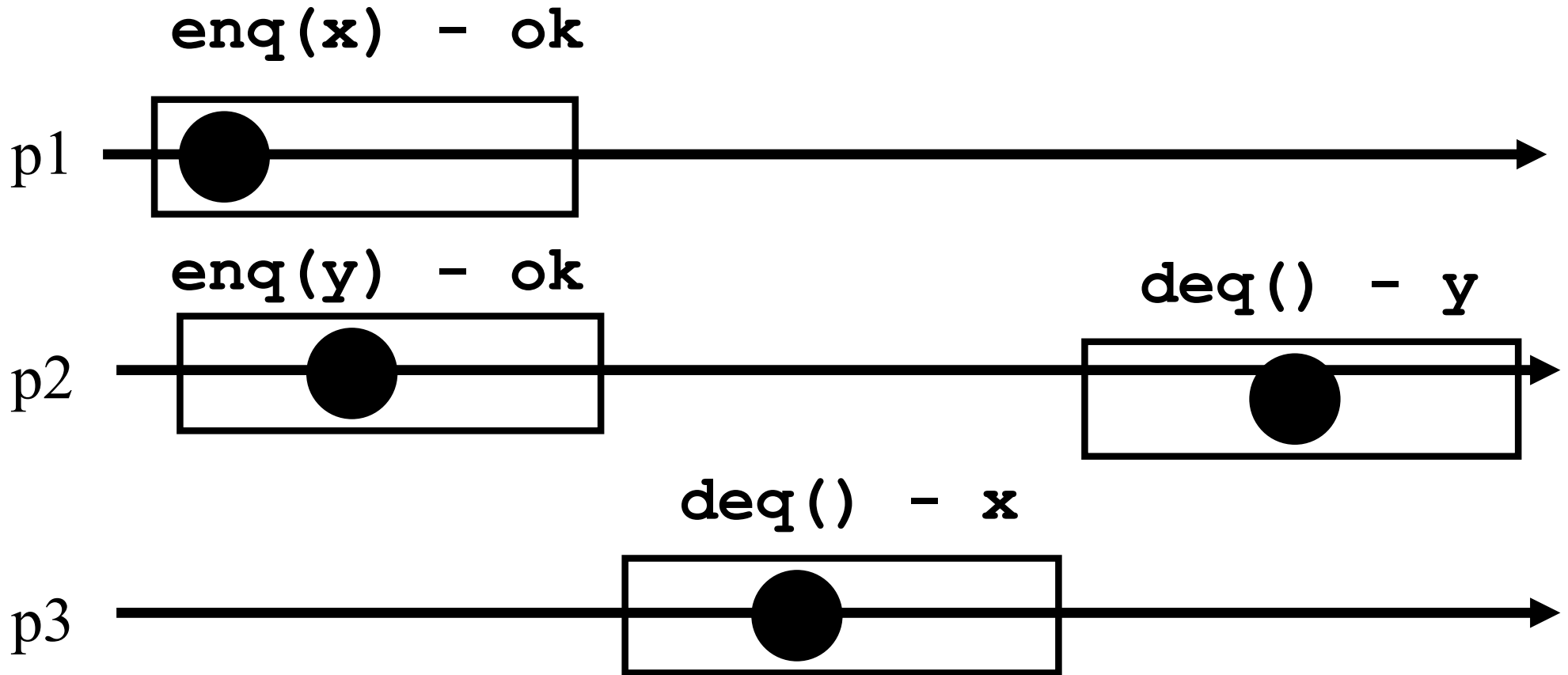

Atomicity?

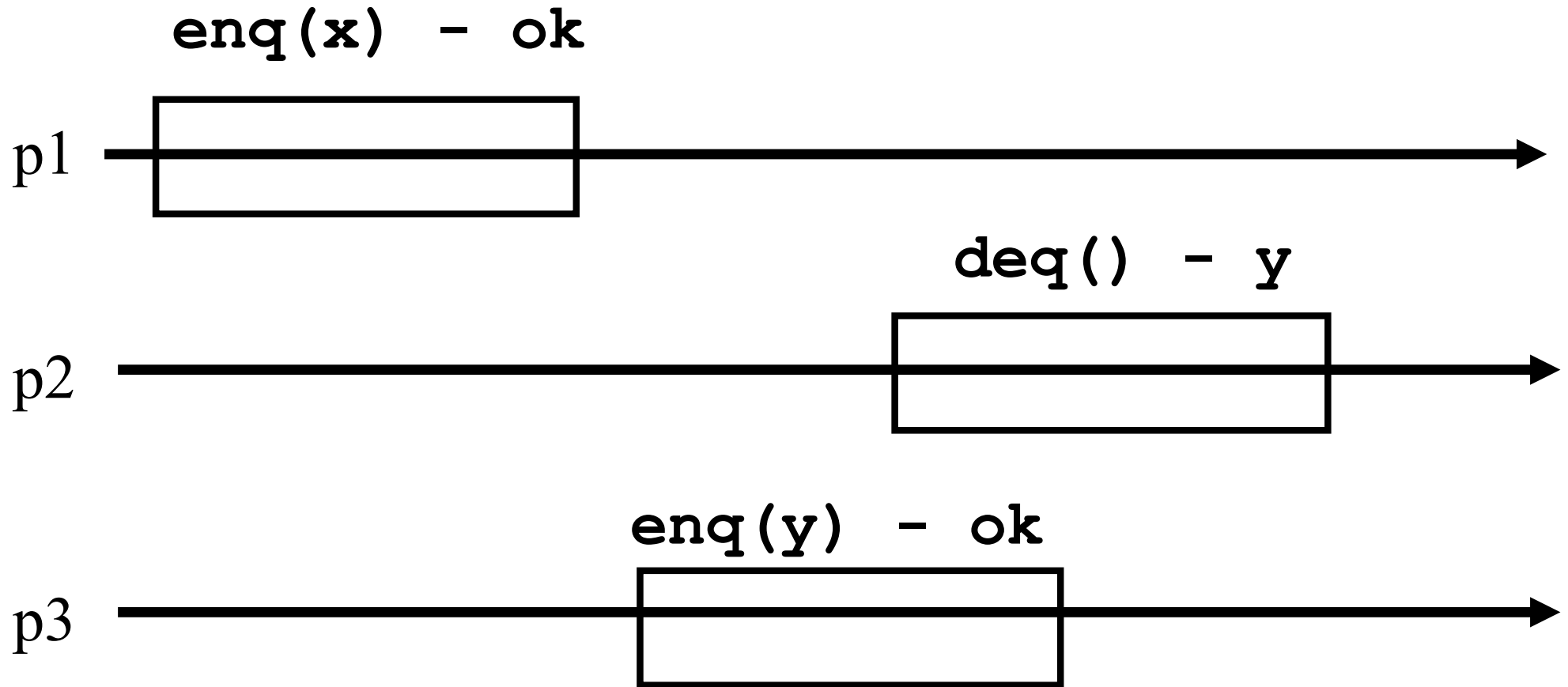

Atomicity?

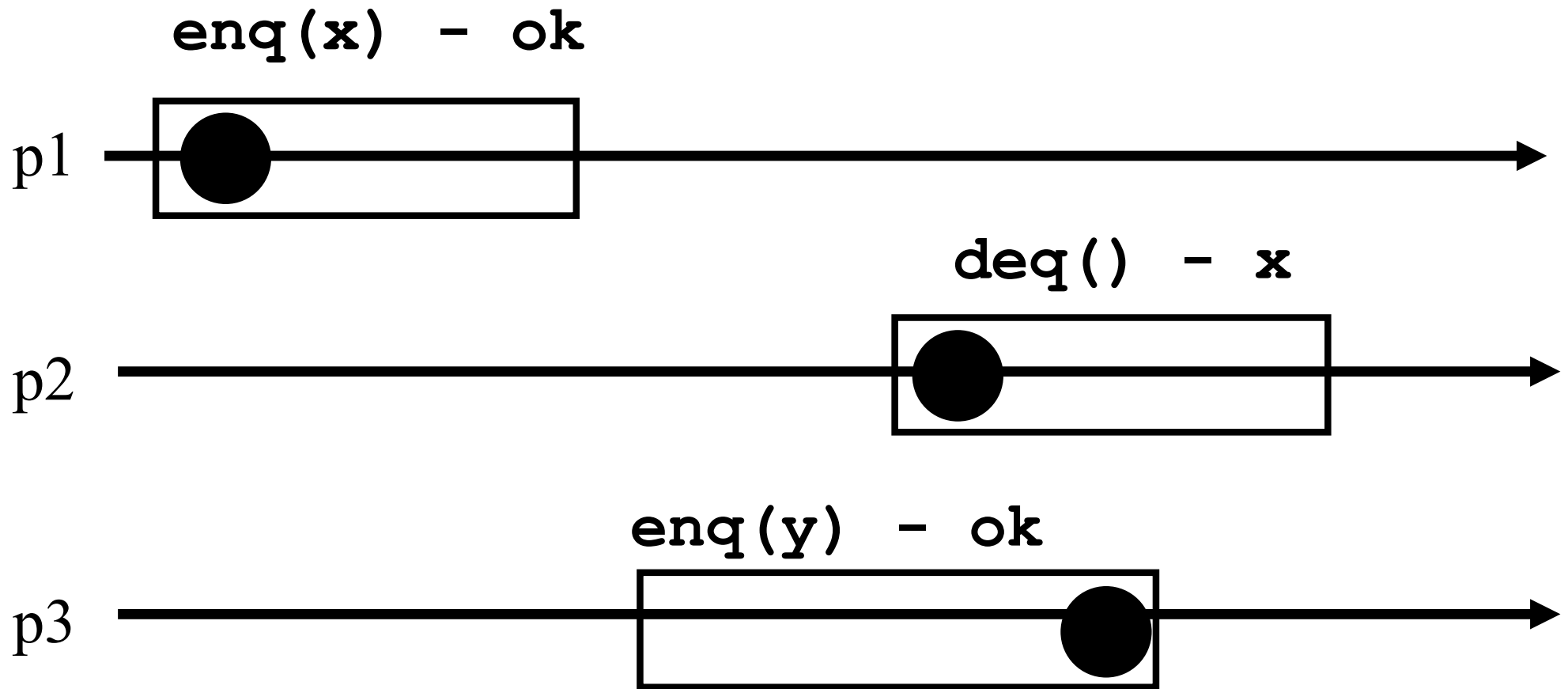

Roadmap

- ☛ Model
 - ☛ Processes and objects
 - ☛ Atomicity and wait-freedom
- ☛ Examples
- ☛ Content

Content

- ☛ (1) Implementing *registers*
- ☛ (2) The power & limitation of *registers*
- ☛ (3) *Universal* objects & synchronization number
- ☛ (4) *Transactional* memory
- ☛ (5) The power of *time* & failure detection
- ☛ (6) Tolerating *failure* prone objects
- ☛ (7) *Anonymous* implementations
- ☛ (8) **Non-volatile** memory
- ☛ (9) **Hybrid** memory

In short

This course studies how to **wait-free** implement high-level **atomic** objects out of basic objects

Unless explicitly stated otherwise, objects mean **atomic** objects and implementations are **wait-free**